

Multi 340i

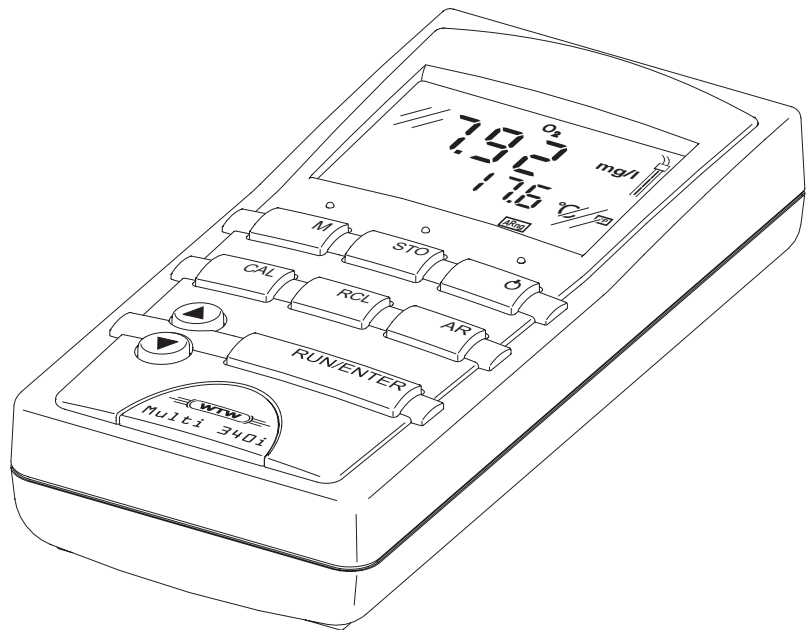

**pH/Dissolved Oxygen/Conductivity
Measuring Instrument**

**Accuracy when
going to press**

The use of advanced technology and the high quality standard of our instruments are the result of continuous development. This may result in differences between this operating manual and your instrument. Also, we cannot guarantee that there are absolutely no errors in this manual. Therefore, we are sure you will understand that we cannot accept any legal claims resulting from the data, figures or descriptions.

Warranty

We guarantee the instrument described for 3 years from the date of purchase.

The instrument warranty covers manufacturing faults that are discovered within the warranty period. The warranty does not cover components that are replaced during maintenance work, e.g. batteries.

The warranty claim extends to restoring the instrument to readiness for use but not, however, to any further claim for damages. Improper handling or unauthorized opening of the instrument invalidates any warranty claim.

To ascertain the warranty liability, return the instrument and proof of purchase together with the date of purchase freight paid or prepaid.

Copyright

© Weilheim 2004, WTW GmbH

Reproduction in whole - or even in part - is prohibited without the express written permission of WTW GmbH, Weilheim.

Printed in Germany.

1	Overview	5
1.1	General features	5
1.2	SETs of equipment	6
1.3	Keypad	8
1.4	Display	9
1.5	Jack field	9
1.6	Operating structure	10
2	Safety	11
2.1	Authorized use	11
2.2	General safety instructions	12
3	Commissioning	13
3.1	Scope of delivery	13
3.2	Initial commissioning	13
4	Operation	15
4.1	Switching on the measuring instrument	15
4.2	pH value / ORP voltage	16
4.2.1	General information	16
4.2.2	Measuring the pH value	18
4.2.3	Measuring the ORP voltage	19
4.2.4	pH calibration	20
4.3	Dissolved oxygen	26
4.3.1	General information	26
4.3.2	Measuring the D. O. concentration	27
4.3.3	Measuring the D. O. saturation	28
4.3.4	AutoRead AR (Drift control)	29
4.3.5	D. O. calibration	30
4.3.6	Salt content correction	33
4.4	Conductivity	34
4.4.1	General information	34
4.4.2	Measuring the conductivity	36
4.4.3	Measuring the salinity	36
4.4.4	AutoRead AR (Drift control)	37
4.4.5	Determining the cell constant (Calibration in the control standard)	38
4.5	Calibration intervals (Int 3, Int 4, Int 5)	41
4.6	Saving data	42
4.6.1	Saving manually	42
4.6.2	Switching on AutoStore (Int 1)	44
4.6.3	Outputting the data storage	46
4.6.4	Clearing the memory	52
4.7	Transmitting data	53
4.7.1	Data transmission interval (Int 2)	53

4.7.2	PC/external printer (RS232 interface)	55
4.7.3	Remote control	55
4.8	Configuration	56
4.9	Reset	60
5	Maintenance, cleaning, disposal	63
5.1	Maintenance	63
5.2	Cleaning	64
5.3	Disposal	64
6	What to do if...	65
6.1	pH system messages	65
6.2	Oxi system messages	67
6.3	Conductivity system messages	68
6.4	General errors	69
7	Technical data	71
8	Lists	77

1 Overview

1.1 General features

The compact precision handheld meter Multi 340i enables you to carry out pH measurements, dissolved oxygen (D. O.) measurements and conductivity measurements quickly and reliably.

The Multi 340i handheld meter provides the maximum degree of operating comfort, reliability and measuring certainty for all applications.

The proven MultiCal[®] and OxiCal[®] calibration procedures and the procedures to determine/set up the cell constant support you in your work with the meter. The special AutoRead function enables precise measurements.

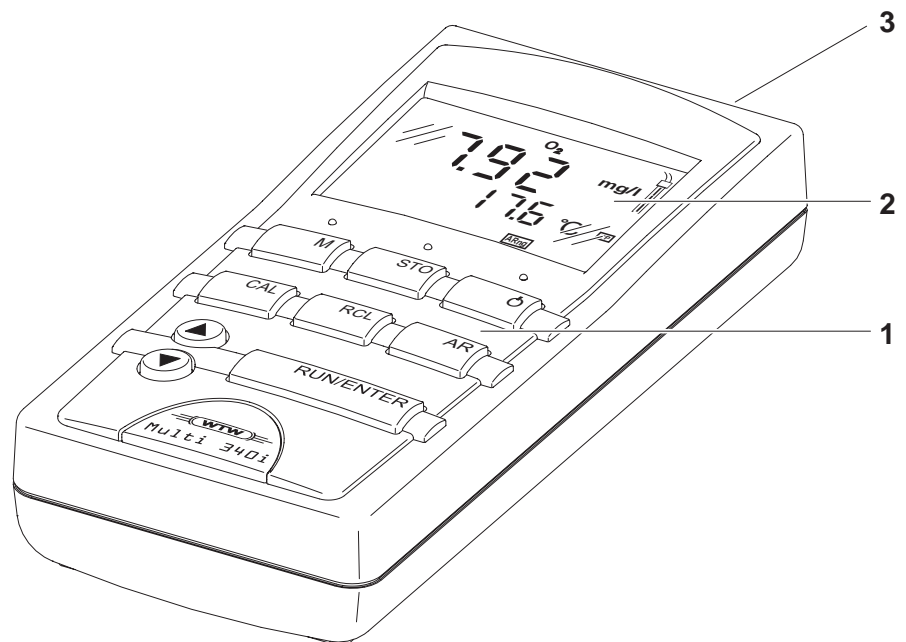

1	Keypad
2	Display
3	Jack field



Note

If you need further information or application notes, you can obtain the following material from WTW:

- Application reports
- Primers
- Safety datasheets.

You will find information on available literature in the WTW catalog or via the Internet.

1.2 SETs of equipment

The measuring instrument is also available as part of individual SETs of equipment.

You will find additional information on this and other accessories in the WTW catalog or via the Internet.

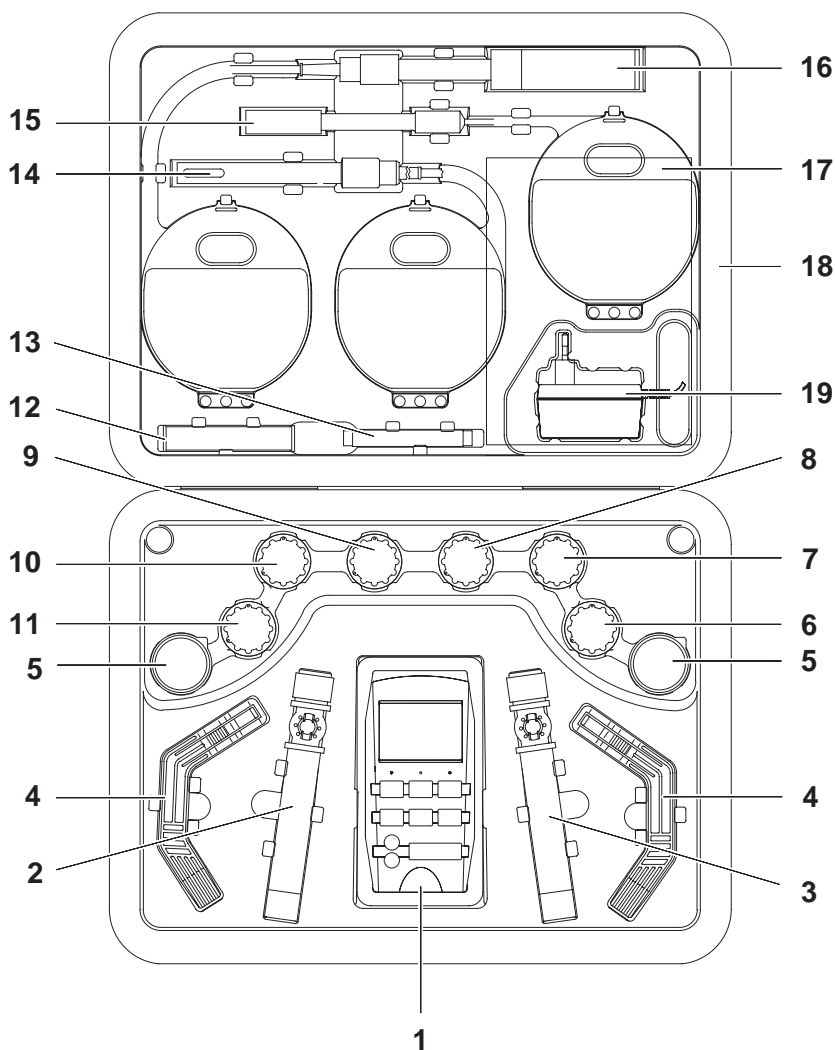

Set (sample configuration):







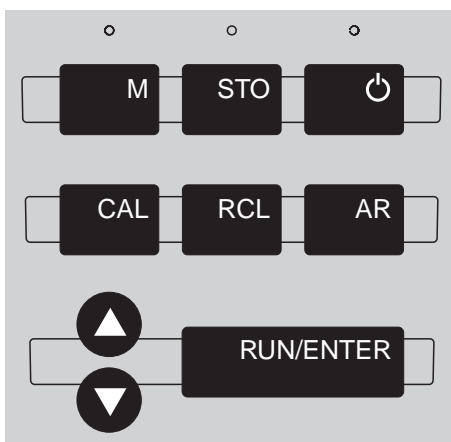

1	Multi 340i meter, carrying strap with 2 carrying clips, armoring
2	Cond/Oxi beaker with beaker clip
3	pH beaker
4	Stand
5	Plastic beaker
6	Storing solution for pH electrodes

7	50 ml pH buffer solution, STP 4
8	50 ml pH buffer solution, STP 7
9	Calibration and control standard for conductivity measuring cells, 50 ml
10	50 ml ELY/G electrolyte solution for D.O. probes
11	50 ml RL/G cleaning solution for D.O. probes
12	WP 90/3 exchange membrane heads for D. O. probes (3 pieces)
13	SF 300 abrasive film for D.O. probes
14	Conductivity measuring cell – TetraCon® 325-3 or – TetraCon® 325
15	pH electrode – SenTix 41-3 or – SenTix 41
16	Oxygen sensor – CellOx 325-3 or – CellOx 325
17	Operating manual + short operating manual
18	Equipment case
19	Plug-in power supply unit

1.3 Keypad



Key functions

	Select the measured variable <M> : – pH value / ORP voltage – D. O. concentration / D. O. saturation – Conductivity / salinity
	Save a measured value <STO>
	Switch measuring instrument on/off <ON/OFF>
	Calibrate the currently set measured variable <CAL>
	Display/transmit measured values <RCL>
	Activate/deactivate the AutoRead function <AR>
	Select the measuring mode, increase values, scroll <▲ >
	Select the measuring mode, decrease values, scroll <▼ >
	Confirm entries, start AutoRead, output measured values <RUN ENTER>

1.4 Display

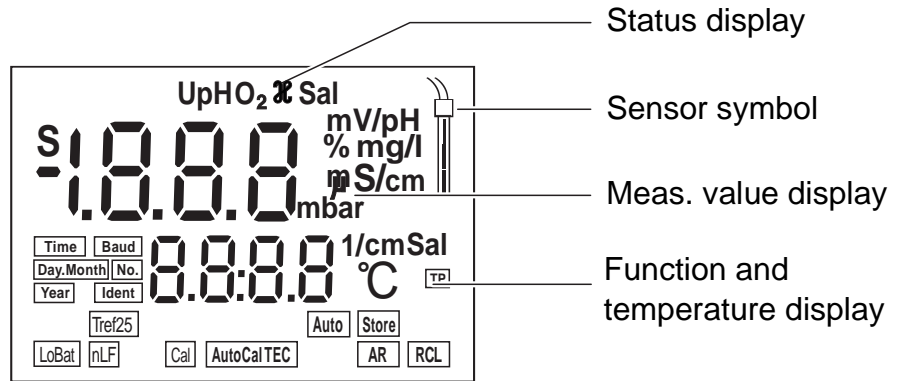

1.5 Jack field

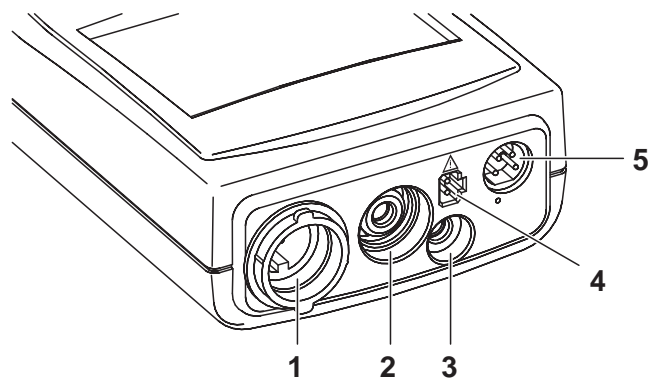

1	D. O. probe or conductivity measuring cell
2	pH electrode
3	pH temperature sensor
4	Plug-in power supply unit
5	RS232 serial interface

1.6 Operating structure

The following overview diagram shows which keys you have to press to select between the different measuring modes:

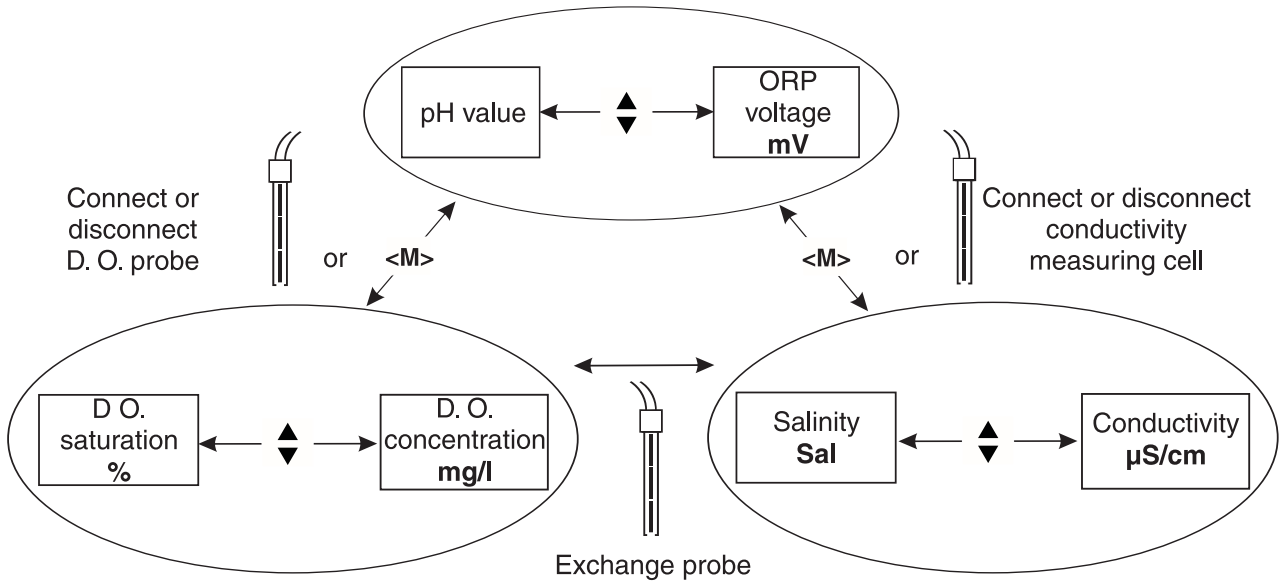

Note

When a D. O. probe or a conductivity measuring cell with a temperature probe is connected, the measuring instrument recognizes the probe or measuring cell and automatically switches to the oxygen measuring mode or conductivity measuring mode last selected. As soon as the probe/measuring cell is disconnected, the instrument switches to the pH or ORP measuring mode.

2 Safety

This operating manual contains basic instructions that you must follow during the commissioning, operation and maintenance of the measuring instrument. Consequently, all responsible personnel must read this operating manual carefully before working with the measuring system. The operating manual must always be available within the vicinity of the measuring system.

Target group

The measuring instrument was developed for work in the field and in the laboratory.

Thus, we assume that, as a result of their professional training and experience, the operators will know the necessary safety precautions to take when handling chemicals.

Safety instructions

The individual chapters of this operating manual use the following safety instruction to indicate various types of danger:



Warning

indicates instructions that must be followed precisely in order to avoid the possibility of slight injuries or damage to the instrument or the environment.

Further notes



Note

indicates notes that draw your attention to special features.



Note

indicates cross-references to other documents, e.g. operating manuals.

2.1 Authorized use

The authorized use of the measuring instrument consists exclusively of the:

- pH and ORP measurement
- measurement of the oxygen content and
- measurement of the conductivity, salinity and temperature in the field and laboratory.

The technical specifications as given in chapter 7 TECHNICAL DATA must be observed. Only the operation and running of the measuring instrument according to the instructions given in this operating manual is authorized. Any other use is considered to be **unauthorized**.

2.2 General safety instructions

This instrument is built and inspected according to the relevant guidelines and norms for electronic measuring instruments (see chapter 7 TECHNICAL DATA).

It left the factory in a safe and secure technical condition.

Function and operating safety

The smooth functioning and operational safety of the measuring instrument can only be guaranteed if the generally applicable safety measures and the specific safety instructions in this operating manual are followed during operation.

The smooth functioning and operational safety of the measuring instrument can only be guaranteed under the environmental conditions that are in specified in chapter 7 TECHNICAL DATA.

If the instrument was transported from a cold environment to a warm environment, the formation of condensate can lead to the faulty functioning of the instrument. In this event, wait until the temperature of the instrument reaches room temperature before putting the instrument back into operation.

Safe operation

If safe operation is no longer possible, the instrument must be taken out of service and secured against inadvertent operation!

Safe operation is no longer possible if the measuring instrument:

- has been damaged in transport
- has been stored under adverse conditions for a lengthy period of time
- is visibly damaged
- no longer operates as described in this manual.

If you are in any doubt, please contact the supplier of the instrument.

Obligations of the purchaser

The purchaser of the measuring instrument must ensure that the following laws and guidelines are observed when using dangerous substances:

- EEC directives for protective labor legislation
- National protective labor legislation
- Safety regulations
- Safety datasheets of the chemical manufacturers.

3 Commissioning

3.1 Scope of delivery

- Multi 340i handheld meter
- Plug-in power supply unit
- Operating manual and short operating manual
- 4 batteries, 1.5 V Mignon type AA (in the instrument)

For details of scope of delivery of SETs, see section 1.2 SETs OF EQUIPMENT and WTW catalog.

3.2 Initial commissioning

Perform the following activities:

- Set the date and time
- Connect the plug-in power supply (optional)

Setting the date and time

1	Press the <M> key and hold it down.
2	Press the <ON/OFF> key. The display test appears briefly on the display.
3	Press the <RUN/ENTER> key repeatedly until the date appears on the display.
4	Set the date of the current day with <▲> <▼> .
5	Confirm with <RUN/ENTER> . The date (month) flashes in the display.
6	Set the current month with <▲> <▼> .
7	Confirm with <RUN/ENTER> . The year appears on the display.
8	Set the current year with <▲> <▼> .
9	Confirm with <RUN/ENTER> . The hours flash on the display.
10	Set the current time with <▲> <▼> .
11	Confirm with <RUN/ENTER> . The minutes flash on the display.
12	Set the current time with <▲> <▼> .

13	Confirm with <RUN/ENTER> . The instrument switches to a measuring mode.
----	---

14	Switch the instrument off using <ON/OFF> .
----	---

Connecting the plug-in power supply

You can either operate the measuring instrument with batteries or with the plug-in power supply. The plug-in power supply supplies the measuring instrument with low voltage (12 VDC). This saves the batteries.



Warning

The line voltage at the operating site must lie within the input voltage range of the original plug-in power supply (see chapter 7 TECHNICAL DATA).



Warning

Use original plug-in power supplies only (see chapter 7 TECHNICAL DATA).

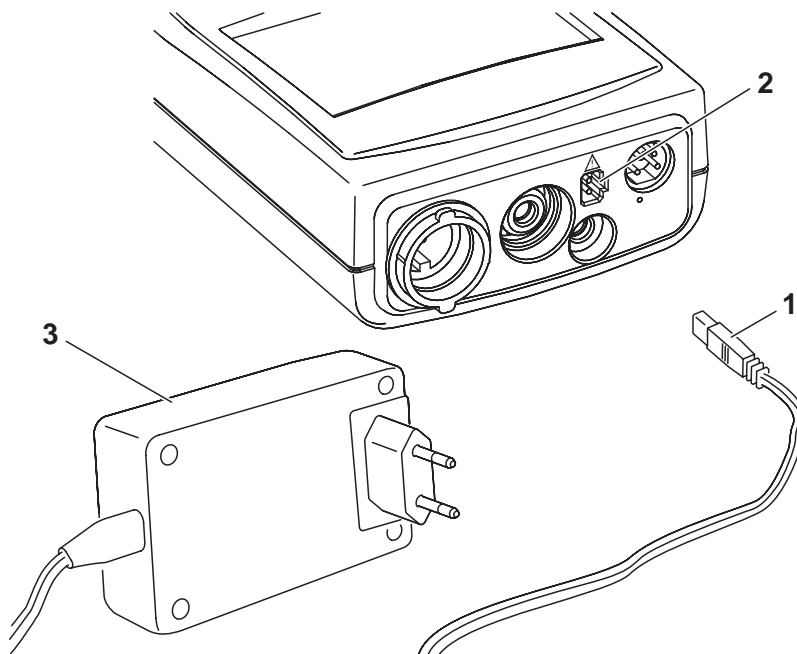

1	Plug the jack (1) into the socket (2) of the measuring instrument.
---	--

2	Connect the original WTW plug-in power supply (3) to an easily accessible mains socket.
---	---

4 Operation

4.1 Switching on the measuring instrument

- 1 Press the <ON/OFF> key.
The display test appears briefly on the display.
After this, the measuring instrument automatically switches to the measuring mode.

Measuring mode when switching on

Connected sensor	Measuring mode
No sensor or pH/ORP electrode	pH or ORP measurement (depending on the last selected setting)
D. O. probe or conductivity measuring cell	Last selected measuring mode
2 sensors of any type	Last selected measuring mode



Note

The measuring instrument has an energy saving feature to avoid unnecessary battery depletion. The energy saving feature switches the measuring instrument off if no key has been pressed for an hour.

The energy saving feature is not active

- if the power is supplied by the plug-in power supply,
- if the AutoStore function is active,
- if the communication cable and a PC with a running communication program are connected,
- if the printer cable is connected (for external printers).

AutoRange measurement range selection

There are several measuring ranges available for both oxygen and conductivity measurements. As a rule, the measuring instrument is in the measuring range with the highest possible resolution. If a measuring range is exceeded, AutoRange causes the measuring instrument to change automatically to the next higher measuring range. The AutoRange function is always active with oxygen and conductivity measurements and cannot be switched off.



Note

The measuring ranges for oxygen and conductivity measurements can be found in chapter 7 TECHNICAL DATA.

4.2 pH value / ORP voltage

4.2.1 General information

Preparatory activities

Perform the following preparatory activities when you want to measure:

1	Connect the pH electrode to the measuring instrument. If necessary, press the <M> key repeatedly until the status display <i>pH</i> (pH measurement) or <i>U</i> (measurement of the ORP voltage) appears.
2	Adjust the temperature of the buffer solutions or test solutions, or measure the current temperature, if you measure without a temperature sensor.
3	Calibrate or check the measuring instrument with the electrode.
4	Using <▲ > <▼> , toggle between the <i>pH</i> or <i>mV</i> measuring modes.



Note

Incorrect calibration of pH electrodes leads to incorrect measured values. Calibrate regularly before measuring. You can only connect electrodes of the NTC30 type or without temperature sensor.



Warning

When connecting an earthed PC/printer, measurements cannot be performed in earthed media as incorrect values would result. The RS232 interface is not galvanically isolated.

Temperature measurement in pH measurements

You can perform pH measurements with or without a temperature sensor as well as with the temperature sensor of an oxygen sensor or a conductivity measuring cell. The measuring instrument recognizes which sensors are connected and switches automatically to the correct mode for the temperature measurement.

The following cases are distinguishable.

Temperature sensor		Display	Mode
<i>pH</i>	<i>Cond or Oxi</i>		
yes	-	<i>TP</i>	Automatic with pH temperature sensor
yes	yes	<i>TP</i>	
-	-		Manual
-	yes	<i>TP</i> flashes	The temperature value of the second probe (Cond or Oxi) in the same sample is taken over for the pH measurement*

* If you do not wish that, you can:

- either disconnect the 2nd sensor and use the manual temperature input or
- use an electrode with a temperature sensor.

If a temperature sensor is connected, it is indicated on the display by *TP*.



Note

When calibrating without a temperature sensor (no *TP* display indicator displayed), enter the current temperature of the respective buffer solution manually using the <▲> <▼> keys while keeping the <RUN/ENTER> key depressed.

4.2.2 Measuring the pH value

1	Perform the preparatory activities according to section 4.2.1.
2	Immerse the pH electrode in the test sample.
3	Press the <▲> <▼> keys until <i>pH</i> appears in the status display. The pH value appears on the display.

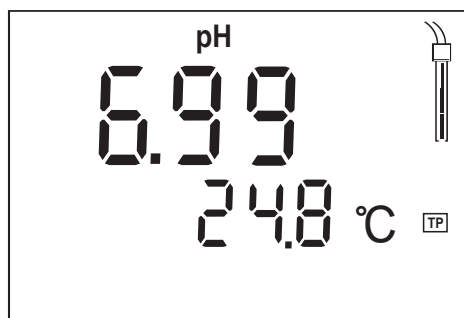

4	<p>When measuring without a connected temperature sensor:</p> <p>Options:</p> <ul style="list-style-type: none"> ● Determine the current temperature using a thermometer and, while keeping the <RUN/ENTER> key depressed, enter this temperature value with <▲> <▼>. ● <i>TP</i> display indicator not displayed, socket for the second probe is free: Connect the second probe (Oxi or Cond) and immerse it in the same sample. <i>TP</i> flashes, the temperature is automatically measured using the second probe.
---	--

AutoRead AR (Drift control)

The AutoRead function (drift control) checks the stability of the measurement signal. The stability has a considerable impact on the reproducibility of the measured values.

For identical measurement conditions, the following criteria apply:

Reproducibility	Response time
Better than 0.02	> 30 seconds

1	Call up the pH measuring mode with <▲> <▼>.
2	Activate the AutoRead function with <AR>. The current measured value is frozen (hold function).

3	Start AutoRead with <RUN/ENTER> . AR flashes until a stable measured value is reached. This measured value is transmitted to the interface.
4	If necessary, start the next AutoRead measurement with <RUN/ENTER> .
5	To terminate the AutoRead function: Press the <AR> key.

**Note**

The current AutoRead measurement can be terminated at any time (accepting the current value) by pressing **<RUN/ENTER>**.

4.2.3 Measuring the ORP voltage

In conjunction with an ORP electrode, e.g. SenTix ORP, the measuring instrument can measure the ORP voltage (U) of a solution.

1	Perform the preparatory activities according to section 4.2.1.
2	Submerge the Redox electrode in the sample.
3	Press the <▲> <▼> keys until the <i>U</i> status display appears. The ORP voltage (mV) of the sample appears on the display.
4	Wait for a stable measured value.

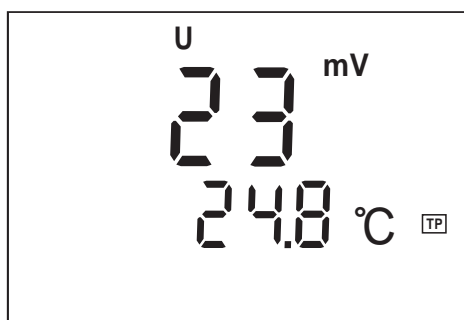
**Note**

ORP electrodes are not calibrated. However, you can check ORP electrodes using a test solution.

4.2.4 pH calibration

Why calibrate?

pH electrodes age. This changes the asymmetry (zero point) and slope of the pH electrode. As a result, an inexact measured value is displayed. Calibration determines the current values of the asymmetry and slope of the electrode and stores them in the measuring instrument. Thus, you should calibrate at regular intervals.

When to calibrate?

- After connecting another electrode
- When the sensor symbol flashes:
 - after the calibration interval has expired
 - after a voltage interruption, e. g. after changing the batteries

AutoCal TEC

is specially matched to the WTW technical buffer solutions as a fully automatic **two-point calibration**. The buffer solutions are automatically recognized by the measuring instrument. Depending on the instrument setting (see section 4.8 CONFIGURATION), the instrument displays the relevant buffer nominal value or the current electrode voltage in mV. The calibration can be terminated after the first buffer solution. This corresponds to a **single-point calibration**. To do this, the instrument uses the Nernst slope (-59.2 mV/pH at 25 °C) and determines the asymmetry of the electrode.

AutoRead

The calibration procedure automatically activates the AutoRead function. The current AutoRead measurement can be terminated at any time (accepting the current value) by pressing **<RUN/ENTER>**.

Displaying the calibration data

You can view the data of the last calibration on the display. The proceeding is described on page 48.

Printing the calibration protocol

The calibration record contains the calibration data of the current calibration. You can transmit the calibration protocol to a printer via the serial interface (see OUTPUTTING THE CALIBRATION PROTOCOL ON THE INTERFACE, page 51).



Note

You can automatically print a calibration record after the calibration. To do so, connect a printer to the interface according to section 4.7.2 before calibrating. After a valid calibration, the record is printed.

Sample printout:





```

CALIBRATION PROTOCOL
02.03.01      14:19
Device No.: 12345678
Calibration pH
Cal time: 01.03.01 / 15:20
Cal interval: 7d
AutoCal TEC   Tauto
Buffer 1      2.00
Buffer 2      4.01
Buffer 3      7.00 *
Buffer 4      10.00
C1            184.1 mV  25.0°C
C2            3.0 mV   25.0°C
S1           -59.4 mV/pH
ASY1         - 4 mV
Probe:       +++

```

Calibration evaluation

After calibrating, the measuring instrument automatically evaluates the calibration. The asymmetry and slope are evaluated separately. The worst evaluation appears on the display.

Display	Asymmetry [mV]	Slope [mV/pH]
	-15 ... +15	-60.5 ... -58
	-20 ... +20	-58 ... -57
	-25 ... +25	-61 ... -60.5 or -57 ... -56
 Clean the electrode according to the electrode operating manual	-30 ... +30	-62 ... -61 or -56 ... -50
E3 Eliminate the error according to chapter 6 WHAT TO DO IF...	< -30 or > 30	... -62 or ... -50

Preparatory activities

1	Connect the pH electrode to the measuring instrument. If necessary, press the <M> key repeatedly until the status display <i>pH</i> (pH measurement) or <i>U</i> (measurement of the ORP voltage) appears.
2	Keep the buffer solutions ready.
3	Adjust the temperature of the solution and measure the current temperature if the measurement is made without the use of a temperature sensor (the <i>TP</i> display indicator is missing from the display).

AutoCal TEC

For this procedure, use any two WTW technical buffer solutions (pH values at 25 °C: 2.00 / 4.01 / 7.00 / 10.01).

**Note**

The calibration for pH 10.01 is optimized for the WTW technical buffer solution TEP 10 Trace or TPL 10 Trace. Other buffer solutions can lead to an erroneous calibration. The correct buffer solutions are given in the WTW catalog or in the Internet.

**Note**

The buffer solutions are automatically recognized by the measuring instrument. Depending on the instrument setting (see section 4.8 CONFIGURATION), the instrument displays the relevant buffer nominal value or the current electrode voltage in mV.

**Note**

Skip the steps 2 and 7 if you use a pH electrode with temperature sensor or the temperature sensor of a conductivity measuring cell or a D. O. probe.

Starting the calibration

1	Press the <CAL> key. The <i>Ct1</i> display and the function display <i>AutoCal TEC</i> appears. The sensor symbol displays the evaluation of the last calibration (or no sensor symbol in the delivery state or after the measurement parameter has been reset).
---	--

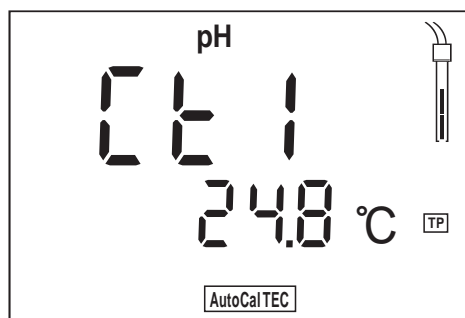

- 2 If required, enter the temperature of the first buffer solution, while keeping the <RUN/ENTER> key depressed, using <▲> <▼>.
- 3 Immerse the pH electrode in the first buffer solution.
- 4 Press the <RUN/ENTER> key.
The AR display indicator flashes.
The electrode voltage (mV) or the buffer nominal value appears on the display. Example:

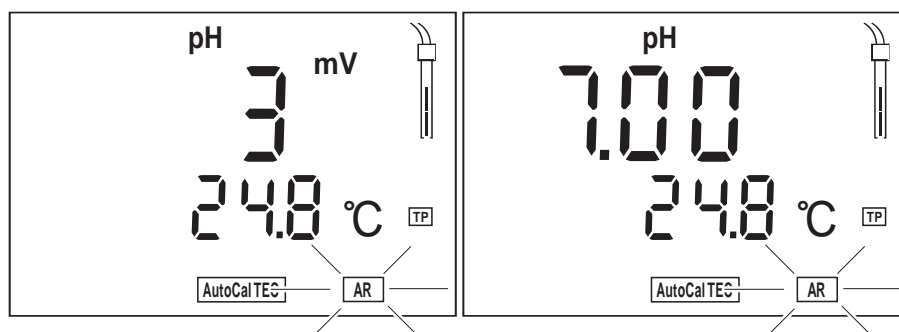

- 5 When the measured value is stable, Ct2 appears.

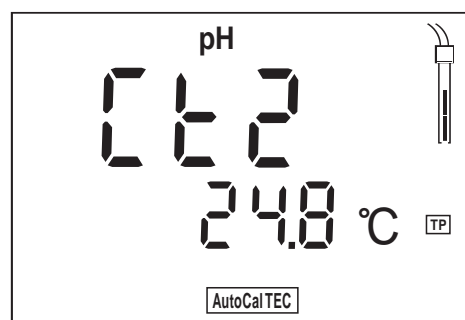

Note

At this point, the AutoCal TEC calibration can be terminated with <M>. This corresponds to a **single-point calibration**. To do this, the instrument uses the Nernst slope (-59.2 mV/pH at 25 °C) and determines the asymmetry of the electrode.

- | | |
|---|--|
| 6 | Thoroughly rinse the electrode with distilled water. |
| 7 | If required, enter the temperature of the first buffer solution, while keeping the <RUN/ENTER> key depressed, using <▲> <▼>. |
| 8 | Immerse the pH electrode in the second buffer solution. |
| 9 | Press the <RUN/ENTER> key.
The AR display indicator flashes.
The electrode voltage (mV) or the buffer nominal value appears on the display. Example: |

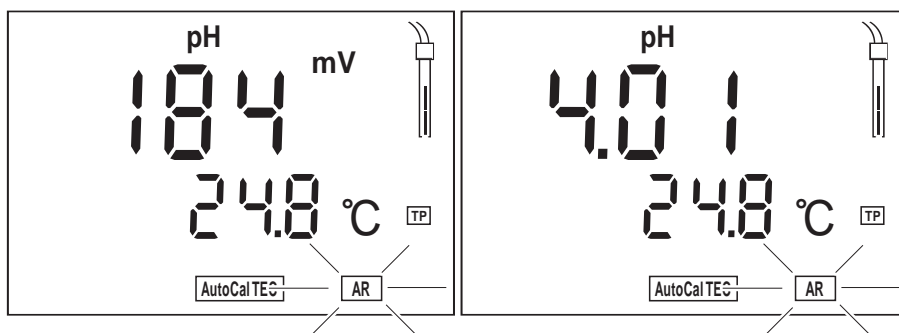

- | | |
|----|--|
| 10 | When the measured value is stable, AR disappears. The value of the slope (mV/pH) appears on the display. The probe symbol shows the evaluation of the current calibration. |
|----|--|

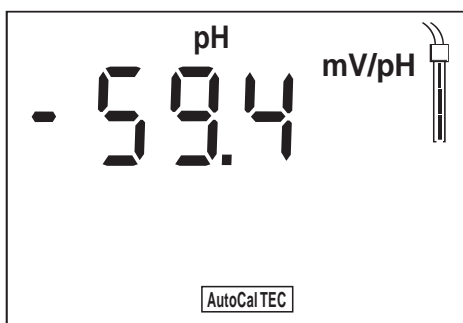

- | | |
|----|--|
| 11 | Press the <RUN/ENTER> key. The value of the asymmetry (mV) appears on the display. |
|----|--|

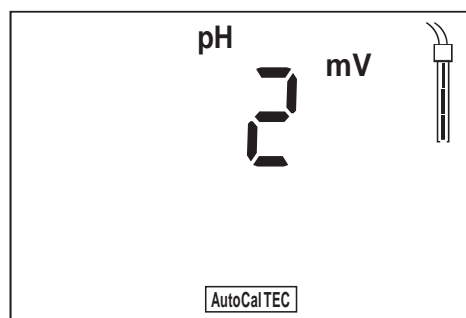

12 | Switch to the measuring mode with **<M>**.

4.3 Dissolved oxygen

4.3.1 General information



Note

D. O. measurements with the Multi 340i can only be carried out using a CellOx 325 or StirrOx G D. O. probe. The stirrer of the StirrOx G D. O. probe has to be supplied with voltage separately using the NT/pH Mix 540 power supply.

You can measure the following variables:

- D. O. concentration
- D. O. saturation

The measuring instrument is supplied with the following functions:

- AutoRange (automatic switchover of the measurement range),
- The AutoRead function (drift control) for checking the stability of the measurement signal. This ensures the reproducibility of the measuring signal. For details of how to switch the AutoRead function on/off, see page 29.



Warning

When connecting an earthed PC/printer, measurements cannot be performed in earthed media as incorrect values would result. The RS232 interface is not galvanically isolated.

Preparatory activities

Perform the following preparatory activities when you want to measure:

1	Connect the D. O. probe to the measuring instrument. The instrument automatically switches over to D. O. measurement (O_2 status display). If the D. O. probe is already connected, press the <M> repeatedly until the O_2 status display appears.
2	Calibrate or check the measuring instrument with the sensor. How to calibrate is described in section 4.3.5 from page 20.
3	Use <▲> <▼> to toggle between the measuring modes, D. O. concentration (<i>mg/L</i>) and D. O. saturation (%).



Note

Incorrect calibration of D. O. probes will result in incorrect measured values. Calibrate at regular intervals.

Temperature sensor

The D. O. probe has an integrated temperature sensor that always measures the current temperature of the test sample.

4.3.2 Measuring the D. O. concentration

When measuring the concentration of test samples with a salt content of more than 1 g/l, a salinity correction is required.



Note

How to enter the current salt content is described in section 4.3.6 SALT CONTENT CORRECTION on page 33.

Switching the salt content correction on or off, see below.

To measure the D. O. concentration with and without salt content correction, proceed as follows:

1	Perform the preparatory activities according to section 4.3.1.
2	Immerse the D. O. probe in the test sample.
3	Press the <▲> <▼> key repeatedly until the D. O. concentration in <i>mg/l</i> appears on the display.

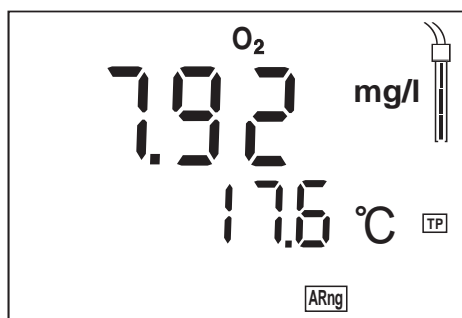

Switching on/off the salt content correction

Proceed as follows to switch on the salt content correction:

1	Perform the preparatory activities according to section 4.3.1.
2	Immerse the D. O. probe in the test sample.
3	While pressing the <RUN/ENTER> key, switch on the salt content correction with <▲>. The SAL display indicator appears on the display. The specified salt content is taken into consideration during the measurement.

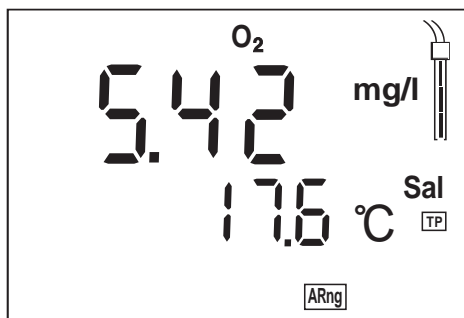

- 4 While pressing the **<RUN/ENTER>** key, switch off the salt content correction with **<▼>**. The SAL display indicator is no longer displayed.

4.3.3 Measuring the D. O. saturation

You can measure the D. O. saturation as follows:

- 1 Perform the preparatory activities according to section 4.3.1.
- 2 Immerse the D. O. probe in the test sample.
- 3 Press the **<▲>** **<▼>** key repeatedly until the D. O. saturation in % appears on the display.

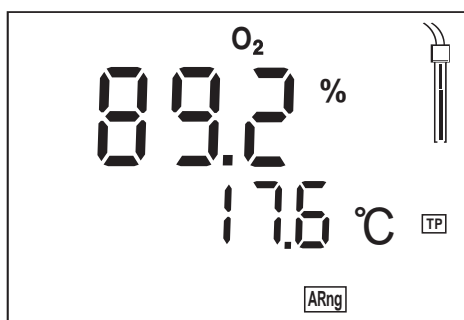

4.3.4 AutoRead AR (Drift control)

The AutoRead function (drift control) checks the stability of the measurement signal. The stability has a considerable impact on the reproducibility of the measured values.

1	Call up the measuring mode with <M> and/or <▲> <▼> .
2	Activate the AutoRead function with <AR> . The current measured value is frozen (hold function).
3	Start AutoRead with <RUN/ENTER> . AR flashes until a stable measured value is reached. This measured value is transmitted to the interface.

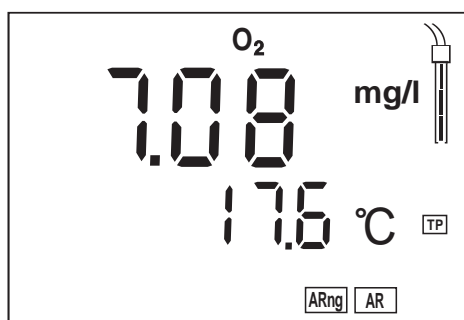

4	If necessary, start the next AutoRead measurement with <RUN/ENTER> .
5	To terminate the AutoRead function: Press the <AR> key.

Criteria With identical measurement conditions, the following applies:

Measuring mode	Reproducibility	Response time
D. O. concentration	Better than 0.05 mg/l	> 10 seconds
D. O. saturation index	Better than 0.6 %	> 10 seconds

4.3.5 D. O. calibration

Why calibrate?

D. O. probes age. This changes the slope of the D. O. probe. Calibration determines the current slope of the probe and stores this value in the instrument.

When to calibrate?

- After connecting another D. O. probe
- When the probe symbol flashes (after the calibration interval has expired).

Calibration procedure

The calibration is performed in water vapor-saturated air. Use the OxiCal[®]-SL air calibration vessel (accessories) for the calibration.

AutoRead

The calibration procedure automatically activates the AutoRead function. The AR display indicator flashes. The calibration process is finished when AR stops flashing.

Displaying the calibration data

You can view the data of the last calibration on the display. The proceeding is described on page 48.

Printing the calibration protocol

The calibration record contains the calibration data of the current calibration. You can transmit the calibration protocol to a printer via the serial interface (see page 51).



Note



You can automatically print a calibration record after the calibration. To do so, connect a printer to the interface according to section 4.7.2 before calibrating. After a valid calibration, the record is printed.

Sample printout:

```
CALIBRATION PROTOCOL
02.03.01 14:19
Device No.: 12345678
CALIBRATION 02
Cal time: 02.03.01 / 14:19
Cal interval: 14d
OxiCal Tauto AR
Relative Slope: 0,88
Probe: +++
```

Probe evaluation

After the calibration, the measuring instrument evaluates the current status of the probe against the relative slope. The evaluation appears on the display. The relative slope has no effect on the measuring accuracy. Low values indicate that the electrolyte will soon be depleted and the probe will have to be regenerated.

Display	Relative slope
	$S = 0.8 \dots 1.25$
	$S = 0.7 \dots 0.8$
	$S = 0.6 \dots 0.7$
E3 Eliminate the error according to chapter 6 WHAT TO DO IF...	$S < 0.6$ or $S > 1.25$

Starting the calibration

Proceed as follows to calibrate the instrument:

1	Perform the preparatory activities according to section 4.3.1.
2	Keep the OxiCal [®] -SL air calibration vessel ready.

**Note**

The sponge in the air calibration vessel must be moist (not wet). Follow the instructions in the OxiCal[®]-SL operating manual.

3	Put the D. O. probe into the air calibration vessel.
4	Press the <CAL> key repeatedly until the calibration mode appears. The sensor symbol displays the evaluation of the last calibration (or no sensor symbol in the delivery state or after the measurement parameter has been reset).

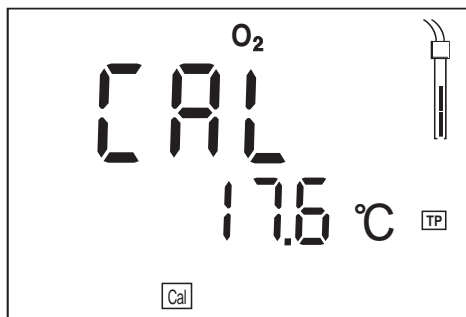

5 Press the <RUN/ENTER> key. AutoRead is active, AR flashes.

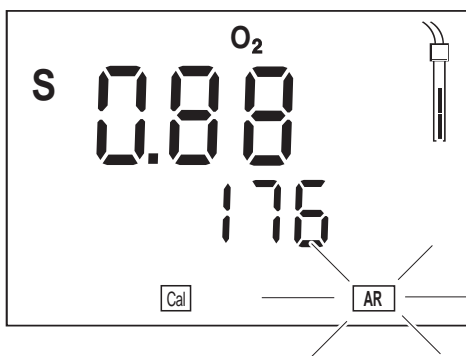

6 As soon as a stable value is reached, the AR display indicator stops flashing. The calibration is finished now. The value of the relative slope appears on the display. The probe symbol shows the probe evaluation (see page 31).

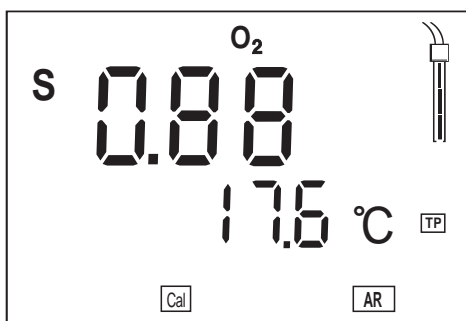

7 Switch to the measuring mode with <M>.



Note

In chapter 6 WHAT TO DO IF... page 65, you will find the measures to take for error elimination.

4.3.6 Salt content correction

A salt content correction is required in the oxygen concentration measurement of samples with a salt content of more than 1 g/l. To do this, you have to enter the salinity equivalent of the test sample (range 0.0 - 70.0) and to switch on the salinity correction.



Note

With the Multi 340i handheld meter, you can measure the salinity. How to proceed is described in section 4.4.3 MEASURING THE SALINITY on page 36.

Entering the salt content

1	Determine the salinity of the test sample (any method, see also section 4.4.3 MEASURING THE SALINITY on page 36).
2	Press the <CAL> key repeatedly until <i>Sal</i> appears on the display.

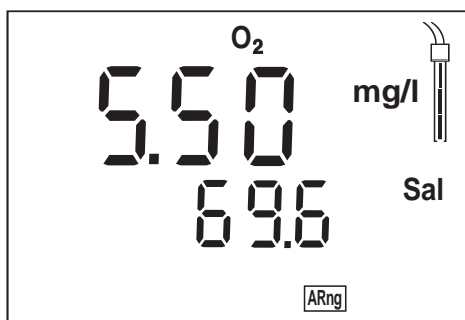

3	Enter the salt content with <▲> <▼>.
4	Switch to the measuring mode with <M>.



Note

How to switch on the salt content correction is described on page 27.

4.4 Conductivity

4.4.1 General information



Note

Conductivity measurements with the Multi 340i can only be carried out using the TetraCon 325 measuring cell.



Warning

When connecting an earthed PC/printer, measurements cannot be performed in earthed media as incorrect values would result. The RS232 interface is not galvanically isolated.

Preparatory activities

Perform the following preparatory activities when you want to measure:

1	Connect a conductivity measuring cell to the measuring instrument. The instrument automatically switches over to conductivity measurement (status display \mathcal{X}). If the conductivity measuring cell is already connected, press the <M> key repeatedly until the status display \mathcal{X} or <i>Sal</i> appears.
2	Check the selected cell constant or calibrate the measuring instrument with the measuring cell (see below).
3	Check the selected cell constant (see below) or calibrate the measuring instrument with the measuring cell (see section 4.4.5 on page 38).
4	Using <▲ > <▼ > , toggle between the measuring modes, conductivity (\mathcal{X} in $\mu S/cm$) or salinity (<i>SAL</i>).

Temperature probe

The TetraCon 325 conductivity measuring cell has a temperature sensor integrated in it. The temperature sensor is shown on the display by *TP*.

Temperature compensation

The nonlinear temperature compensation is set fixed and is shown on the display by *nLF*.

Reference temperature, Tref

The reference temperature (*Tref*) can be switched between 20 °C and 25 °C. It appears on the display as *Tref20* or *Tref25*. To switch over the reference temperature, see SWITCHING OVER THE REFERENCE TEMPERATURE, page 58.

Checking the cell constant

- 1 Press the **<RCL>** key repeatedly until *CAL disp* appears on the display.



- 2 Press the **<RUN/ENTER>** key repeatedly until the last calibrated cell constant is displayed, e. g. 0.472 1/cm.

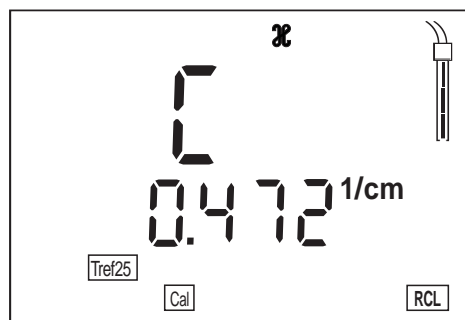

- 3 To return to the measuring mode: Press the **<M>** key when the correct cell constant is displayed.
- 4 If you want to recalibrate the cell constant, proceed according to section 4.4.5 DETERMINING THE CELL CONSTANT (CALIBRATION IN THE CONTROL STANDARD) .

4.4.2 Measuring the conductivity

You can carry out the conductivity measurements as follows:

1	Perform the preparatory activities according to section 4.4.1 page 34.
2	Immerse the conductivity measuring cell in the test sample.
3	Press the <▲> <▼> keys until in the status display, Σ and the unit $\mu\text{S}/\text{cm}$ appears. The conductivity value appears on the display.

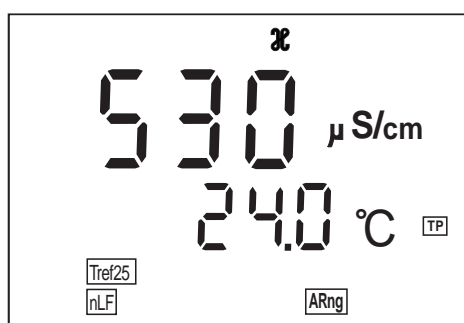

4.4.3 Measuring the salinity

You can carry out the salinity measurements as follows:

1	Perform the preparatory activities according to section 4.4.1 page 34.
2	Immerse the conductivity measuring cell in the test sample.
3	Press the <▲> <▼> keys until the <i>Sal</i> status display appears. The salinity value appears on the display.

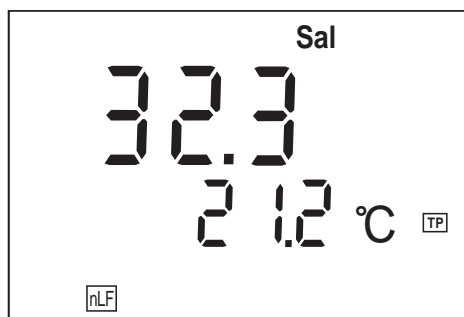

4.4.4 AutoRead AR (Drift control)

The AutoRead function (drift control) checks the stability of the measurement signal. The stability has a considerable effect on the reproducibility of the measured value.

1	Call up the Σ or SAL measuring mode with <M> and/or <▲ > <▼> .
2	Immerse the conductivity measuring cell in the test sample.
3	Activate the AutoRead function with <AR> . The current measured value is frozen (hold function).
4	Start AutoRead with <RUN/ENTER> . AR flashes until a stable measured value is reached. This measured value is transmitted to the interface.

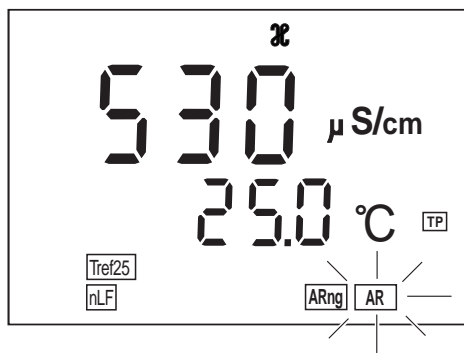

5	If necessary, start the next AutoRead measurement with <RUN/ENTER> .
6	To terminate AutoRead: Press the <AR> key.



Note

The current AutoRead measurement can be terminated at any time (accepting the current value) by pressing **<RUN/ENTER>**. You can only change to another measuring mode after completion of AutoRead.

4.4.5 Determining the cell constant (Calibration in the control standard)

Why determine the cell constant?

Aging slightly changes the cell constant, e. g. by coatings. As a result, an inexact measured value is displayed. The original characteristics of the cell can often be restored by cleaning the cell. Calibration determines the current value of the cell constant and stores this value in the instrument.

Thus, you should calibrate at regular intervals.

In the delivery condition, the cell constant of the measuring instruments is set to 0.475 cm^{-1} (conductivity measuring cell TetraCon 325).

AutoRead

The calibration procedure automatically activates the *AutoRead* function. The *AR* display indicator flashes. The calibration process is finished when *AR* stops flashing.

Displaying the calibration data

You can view the data of the last calibration on the display. The proceeding is described on page 48.

Printing the calibration protocol

The calibration record contains the calibration data of the current calibration. You can transmit the calibration protocol to a printer via the serial interface (see page 51).



Note

You can automatically print a calibration record after the calibration. To do so, connect a printer to the interface according to section 4.7.2 before calibrating. After a valid calibration, the record is printed.

Sample printout:

```
CALIBRATION PROTOCOL
14.04.01      11:37
Device No.: 99990000
Calibration Conductivity
Cal time: 14.04.01 / 11:37
Cal interval: 180d
Cal Std.:    0.01 mol/l KCL
              40.0 °C
Conduct./Tref25: 1413µS/cm
Cell Const : 0.478 1/cm
Probe :      +++
```

Calibration evaluation

After the calibration, the measuring instrument automatically evaluates the current status of the calibration. The evaluation appears on the display.

Display	Cell constant [cm^{-1}]
	0.450 ... 0.500 cm^{-1}
E3 Eliminate the error according to chapter 6 WHAT TO DO IF...	Outside the range 0.450 ... 0.500 cm^{-1}

Determining the cell constant

You can determine the cell constant (conductivity measuring cell Tetra-Con 325) as follows:

- 1 Press the **<CAL>** key repeatedly until the status display ∞ CAL CELL appears.
- 2 Press the **<RUN/ENTER>** key. The CAL display appears, as well as
 - the current, calibrated cell constant (**with** sensor symbol on the display) or
 - the fixed cell constant 0.475 1/cm (**without** sensor symbol on the display). In this case, the measurement parameters are initialized (see section 4.9 RESET).

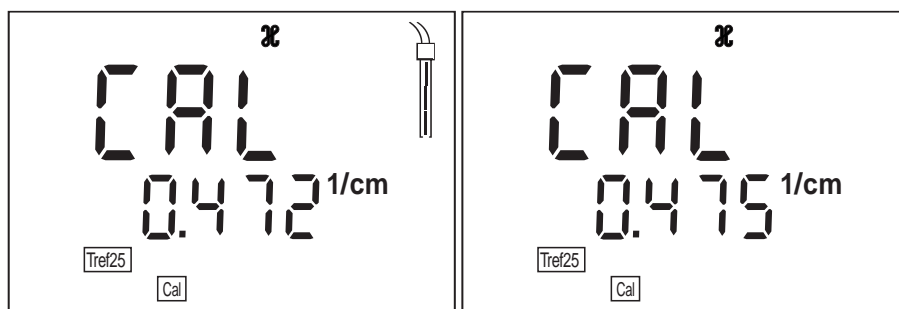

- 3 Immerse the conductivity measuring cell in the control standard solution, 0.01 mol/l KCl.
- 4 Press the **<RUN/ENTER>** key.
The AutoRead measurement to determine the cell constant starts. The AR display indicator flashes until a stable signal is reached. The cell constant determined is displayed. The measuring instrument automatically stores the cell constants.

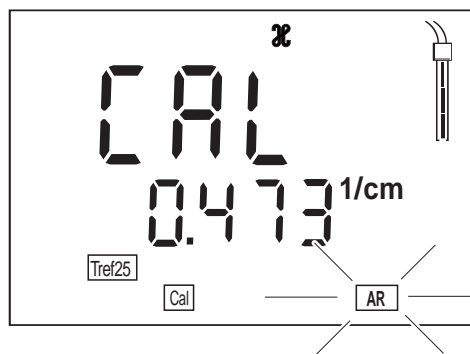

- 5 To return to the measuring mode: Press the **<M>** key. The determined cell constant is taken over for the measurement.

**Note**

If the error message **E3** appears, refer to chapter 6 WHAT TO DO IF...

4.5 Calibration intervals (Int 3, Int 4, Int 5)

For each measured variable, a time interval is stored. When it has expired, you will be reminded to calibrate. After a calibration interval has expired, the probe symbol of the relevant measured variable flashes. It is still possible to measure. By calibrating the relevant probe, the function is reset and the interval starts anew.

The following calibration intervals are set in the factory:

Measured parameter	Designation	Default setting
pH/ORP	<i>Int 3</i>	7 days
Dissolved oxygen	<i>Int 4</i>	14 days
Conductivity	<i>Int 5</i>	180 days

Setting the calibration interval

You can change each of these intervals (1 ... 999 days):

1	Switch off the measuring instrument.
2	Press the <M> key and hold it down.
3	Press the <ON/OFF> key. The display test appears briefly on the display. After this, the measuring instrument automatically switches over to configuration.
4	Press the <RUN/ENTER> key repeatedly, until <i>Int 3 ... 5</i> together with the required measured variable (<i>pH</i> , <i>O₂</i> or <i>ℳ</i>) appears on the display. Example:

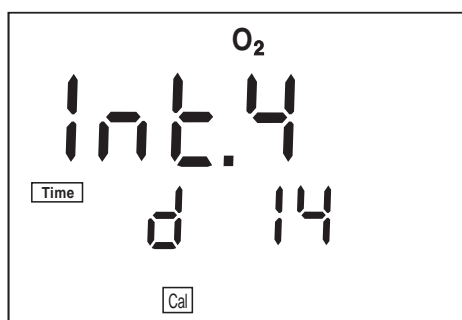

5	Set the required interval until the next calibration with <▲> <▼> .
6	Confirm with <RUN/ENTER> .
7	Switch to the measuring mode with <M> .

4.6 Saving data

The Multi 340i portable measuring instrument has an internal data memory. It can store up to 500 datasets.

A complete data record consists of:

- Number of the storage location
- Date/time
- Measured values of the probes connected
- Temperature values of the probes connected
- Temperature measuring procedure
- ID number

You can transmit measured values (data records) to the data storage in two ways:

- Save manually
- Switch on AutoStore (Int 1), see page 44)

4.6.1 Saving manually

You can transmit a measured value to the data storage as follows:

- 1 Press the **<STO>** key.
The current number (location number *No.*) of the next free storage location appears under the current measured value on the display.

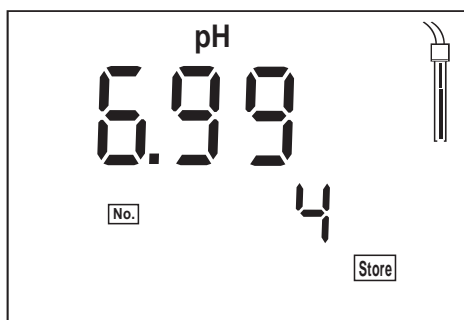

- 2 Confirm with **<RUN/ENTER>**.
The display switches to entering the ID number.

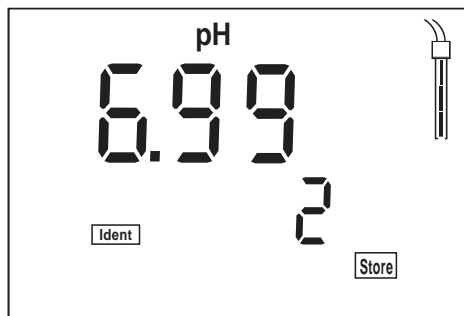

- | | |
|---|---|
| 3 | Using <▲> <▼>, enter the required ID number (1 ... 999). |
| 4 | Confirm with <RUN/ENTER>. The measured values are stored. The instrument changes to the measuring mode. |

Message StoFull

This message appears when all of the 500 storage locations are occupied.

You have the following options:

Saving the current measured value. The oldest measured value (storage location 1) will be overwritten by this	Press <RUN/ENTER>
Returning to the measuring mode without saving	press any key
Outputting the data storage	see section 4.6.3
Clearing the memory	see section 4.6.4

4.6.2 Switching on AutoStore (Int 1)

The save interval (Int 1) determines the chronological interval between automatic save processes. After the fixed interval has expired, the current data record is transmitted to the internal storage and to the interface.

Switching on AutoStore

- 1 Press the **<RUN/ENTER>** key and hold it down.
- 2 Press the **<STO>** key. *Int 1* appears on the display.



- 3 Set the required interval between the saving procedures with **<▲>** **<▼>** (Selection: 5 s, 10 s, 30 s, 1 min, 5 min, 10 min, 15 min, 30 min, 60 min).
- 4 Confirm with **<RUN/ENTER>**.
The number of free memory locations appears on the display.

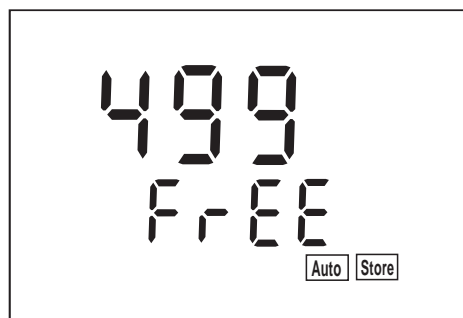

- 5 Confirm with **<RUN/ENTER>**.
The prompt for the ID number appears on the display.

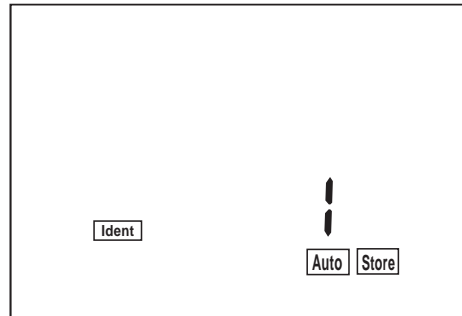

6	Set the required ID number with <▲> <▼>.
7	Confirm with <RUN/ENTER>. The measuring instrument switches to the last active measuring mode and start the measuring and saving procedure. <i>AutoStore</i> flashes on the display.

As soon as all of the 500 storage locations are occupied, AutoStore is terminated (Int 1 = OFF). If there are not enough storage locations available for your measurements:

- Output and backup the data storage (see page 46) and
- clear the memory (see page 52).



Note

The AutoStore function is interrupted if you start other functions, e.g. output the data storage. After the other function is finished, the AutoStore function is continued. By this, however, temporal gaps in the recording of the measured values will occur.

Switching off AutoStore

Switch AutoStore off by:

- setting the save interval (Int 1) to OFF, or
- switching the measuring instrument off and then on again.

4.6.3 Outputting the data storage

You can output the contents of the data storage:

- Stored data on the display
- Calibration data on the display
- Stored data on the serial interface
- Calibration protocol to the interface

Outputting stored data on the display

- 1 Press the **<RCL>** key repeatedly until *StO dISP* appears on the display.



- 2 Press the **<RUN/ENTER>** key.
A measured value appears on the display.
The storage location of the data record is displayed for approx. 2 s, then the respective temperature appears.

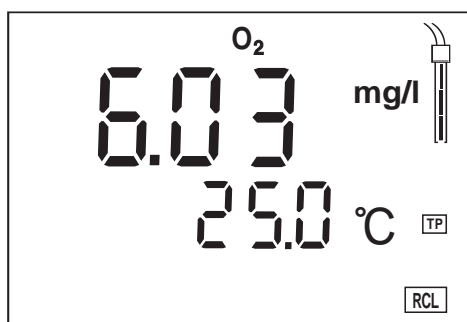

You can perform the following activities:

Display further data of the data record (ID number, date, time, storage location)	Press <RUN/ENTER>
To toggle between two saved measured variables	Press <RUN/ENTER> + <M>
Advance one data record (storage location)	Press <▲>
Go back one data record (storage location)	Press <▼>

**Note**

If you want to search for a certain element of the data record (e.g. date), proceed as follows:

- | | |
|---|--|
| 1 | Using <RUN/ENTER>, select the element (e.g. date). |
| 2 | Press <▲> or <▼> repeatedly until the required element appears on the display.
After approx. 2 s the temperature of the displayed measured value appears. |

Outputting stored data to the interface

- | | |
|---|---|
| 1 | Press the <RCL> key repeatedly until <i>Sto SEr</i> appears on the display. |
|---|---|

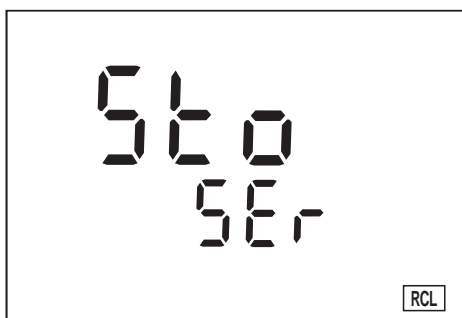

- | | |
|---|--|
| 2 | Press the <RUN/ENTER> key.
The complete contents of the storage are transmitted to the interface. During the data transmission the instrument increments the storage numbers. After the data transmission, the instrument automatically switches to the last active measurement mode. |
|---|--|

**Note**

You can cancel the transmission with <M> or <RUN/ENTER>.

The transmitted data contains the entire contents of the storage in incrementing order of the location numbers.

Sample printout:

```
No.    1:
 09.03.01      17:10
pH 10.01      25 °C
Tauto
Ident : 47

No.    2:
 09.03.01      17:12
 305 mV
Tauto
Ident : 6

No.    3:
 09.03.01      17:24
 7.88 mg/l     17.6° C
Tauto
Ident : 81

No.    4:
 09.03.01      17:46
 7.11 mg/l     17.8° C
Tauto
SAL = 17.9
Ident : 4

No.    5:
 10.03.01      19:09
 2.40 mS/cm    25.3 °C
Tauto
nLF
Tref25 C = 0.475 1/cm
Ident : 10

No.    6:
 10.03.01      20:48
 2.46 mS/cm    25.6 °C
Tauto
nLF
Tref25 C = 0.475 1/cm
Ident : 1
...
```

Outputting the calibration data on the display

- 1 Press the <RCL> key repeatedly until *CAL disp* appears on the display.



- 2 Press the **<RUN/ENTER>** key.
The data of the last calibration of all measured variables appears in the following sequence:
- pH: Slope *SLO* and asymmetry *ASY*
 - Dissolved oxygen: Relative slope *SLO*
 - Cond: Cell constant *C*
- Information concerning the calibration procedure is output as well.

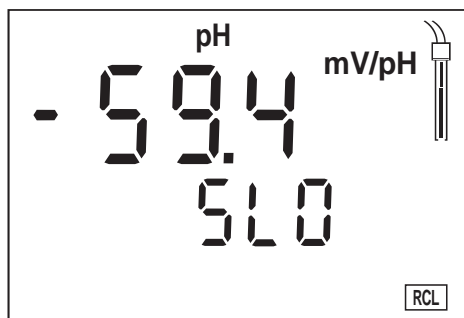

- 3 Press **<RUN/ENTER>** to display the value of the asymmetry (mV).

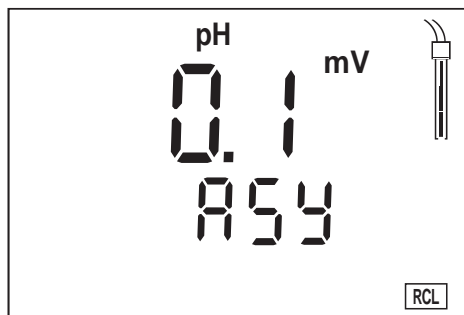

- 4 Press **<RUN/ENTER>** to display the relative slope of the D. O. probe.

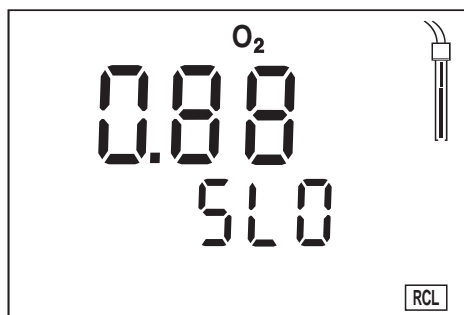

- 5 Press **<RUN/ENTER>** to display the cell constant. The displayed value is:
- the current, calibrated cell constant (**with** sensor symbol on the display) or
 - the fixed cell constant $0.475\ 1/cm$ (**without** probe symbol on the display). In this case, the measured parameters are initialized (see section 4.9 RESET).

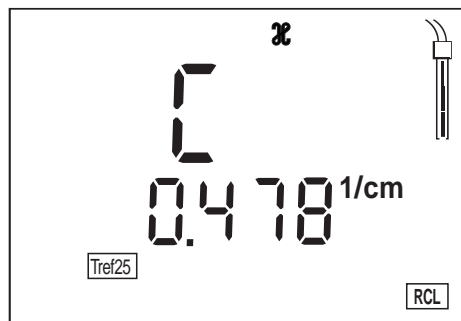

- 6 With **<M>** you can switch back to the last active measuring mode.

Outputting the calibration protocol on the interface

- 1 Press the **<RCL>** key repeatedly until *CAL SEr* appears on the display.

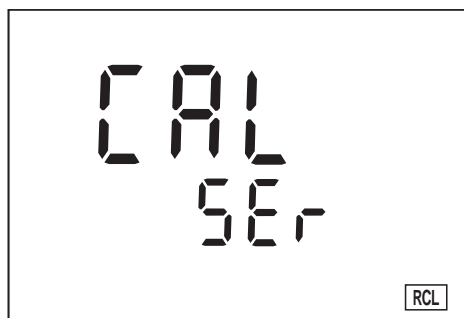

- 2 Press the **<RUN/ENTER>** key. The calibration protocol for all measured variables is transmitted to the interface. After the data transmission, the instrument automatically switches to the last active measurement mode.

Sample printout:

```

CALIBRATION PROTOCOL
02.03.01      14:19
Device No.: 12345678

Calibration pH
Cal time: 01.03.01 / 15:20
Cal interval: 7d
AutoCal TEC   Tauto
Buffer 1      2.00
Buffer 2      4.01
Buffer 3      7.00 *
Buffer 4      10.00
C1            174.1 mV  25.0°C
C2            -133.3 mV 25.0°C
S1            -59.4 mV/pH
ASY1          - 4 mV
Probe:        +++

CALIBRATION 02
Cal time: 02.03.01 / 14:19
Cal interval: 14d
OxiCal        Tauto AR
Relative Slope: 0,88
Probe:        +++

Calibration Conductivity
Cal time: 14.12.00 / 11:37
Cal interval: 180d
Cal Std.:     0.01 mol/l KCL
              40.0 °C
Conduct./Tref25: 1413µS/cm
Cell Const : 0.478 1/cm
Probe :       +++

```

4.6.4 Clearing the memory

With this function, you can delete the stored data records. 500 storage locations will then be available again.

**Note**

The *Clear memory* function only appears when there are data records stored in the memory. Otherwise, the measuring instrument automatically switches to the last active measuring mode.

Proceed as follows to clear all data records:

1	Switch off the measuring instrument.
2	Press the <STO> key and hold it down.
3	Press the <ON/OFF> key. The display test appears briefly on the display.



4	Confirm the clearing process with <RUN/ENTER> . Pressing any other key prevents the clearing, the data records will remain stored.
---	--

**Note**

The calibration data remain stored and can be called up.

4.7 Transmitting data

You have the following possibilities of transmitting data:

- One of the following options:
 - With the *AutoStore* function (page 44), measured values are periodically saved internally (save interval Int 1) and output on the interface.
 - With the *Data transmission interval function* (Int 2), measured values are periodically output on the interface (see below).
 - *AutoStore* (Int 1) covers the *Data transmission interval* (Int 2).
- Press the **<RUN/ENTER>** key
This manually triggers a data transmission of the current measured value to the serial interface at any time - independently of the selected intervals.
- With the *Output data storage* function (page 46), calibration data or saved measured values are output on the interface.

4.7.1 Data transmission interval (Int 2)

The interval to the data transmission (Int 2) determines the chronological interval between automatic data transmissions. After the selected interval expires, the current data record is transmitted to the interface.

The default setting for the interval is OFF.

To start the data transmission, set an interval (5 s, 10 s, 30 s, 1 min, 5 min, 10 min, 15 min, 30 min, 60 min):

Setting the Data transmission interval

- 1 Press the **<RUN/ENTER>** key and hold it down.
- 2 Press the **<RCL>** key. *Int 2* appears on the display.



- 3 Set the required interval between the saving procedures with **<▲>** **<▼>**.

- 4 | Confirm with **<RUN/ENTER>**.
The measuring instrument switches to the last active measuring mode.

**Note**

When the *AutoStore* function is active at the same time, the data transmission is performed according to the setting of the save interval (Int 1). Set the save interval (Int 1) to OFF to activate the *Data transmission interval* (Int 2).

4.7.2 PC/external printer (RS232 interface)

Via the RS 232 interface, you can transmit the data to a PC or an external printer.

Use the AK340/B (PC) or AK325/S (ext. printer) cable.



Warning

The RS232 interface is not galvanically isolated.

When connecting an earthed PC/printer, measurements cannot be performed in earthed media as incorrect values would result.

Set up the following transmission data on the PC/printer:

Baud rate	can be selected from: 1200, 2400, 4800 , 9600
Handshake	RTS/CTS + Xon/Xoff
PC only:	
Parity	none
Data bits	8
Stop bits	2

Socket assignment

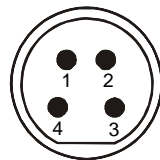

RS 232
REC

- 1 CTS
- 2 RxD
- 3 Ground
- 4 TxD

4.7.3 Remote control

The handheld meter can be remotely controlled from a PC. This requires the KOM pilot communication kit. It is available as an accessory. The instrument is then controlled via commands that simulate key-strokes and request the current display contents.



Note

A more detailed description is provided within the scope of delivery of the communication kit.

4.8 Configuration

You can adapt the handheld meter to your individual requirements. To do this, the following parameters can be changed (the status on delivery is marked in bold):

Baud rate	1200, 2400, 4800 , 9600
Air pressure display	Current value in mbar (no input possible)
Calibration intervals	– pH 1 ... 7 ... 999 dInt 3 – O ₂ 1 ... 14 ... 999 dInt 4 – χ : 1 ... 180 ... 999 dInt 5
Date/time	Any



Note

You can leave the configuration menu at any time with **<M>**. The parameters that have already been changed are stored.

1	Switch off the measuring instrument.
2	Press the <M> key and hold it down.
3	Press the <ON/OFF> key. The display test appears briefly on the display. The measuring instrument then switches automatically to the setting of the baud rate.

Baudrate



4	Select the required Baud rate with <▲> <▼> .
5	Confirm with <RUN/ENTER> . <i>CAL dISP</i> appears on the display.

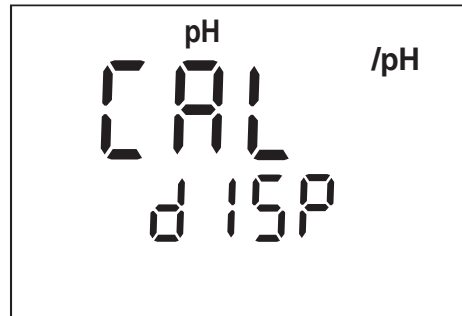

- | | |
|---|---|
| 6 | Select the required display during the pH calibration with $\langle \blacktriangle \rangle$ $\langle \blacktriangledown \rangle$.
<i>mV</i> : Display of the current electrode voltage
<i>/pH</i> : Display of the buffer nominal value. |
| 7 | Confirm with $\langle \text{RUN/ENTER} \rangle$. <i>P mbar</i> appears on the display. |

Displaying the air pressure

The air pressure is only displayed if an oxygen sensor is connected. Otherwise, "---" appears.

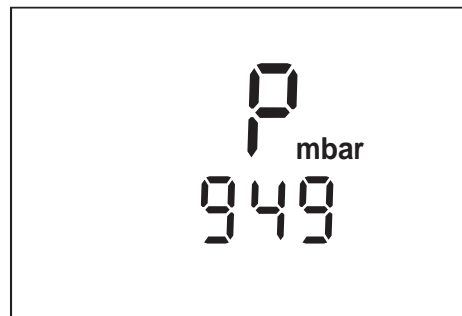

- | | |
|---|--|
| 8 | Confirm with $\langle \text{RUN/ENTER} \rangle$. <i>Int 3</i> and the measured variable pH appear on the display. |
|---|--|

pH calibration interval

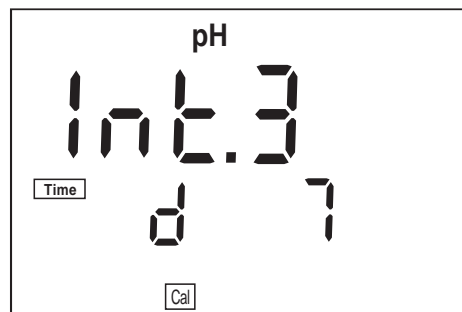

- | | |
|---|--|
| 9 | Set the required interval in days (d) with $\langle \blacktriangle \rangle$ $\langle \blacktriangledown \rangle$. |
|---|--|

- 10 Confirm with **<RUN/ENTER>**. *Int 4* and the measured variable O₂ appear on the display.

Dissolved oxygen calibration interval

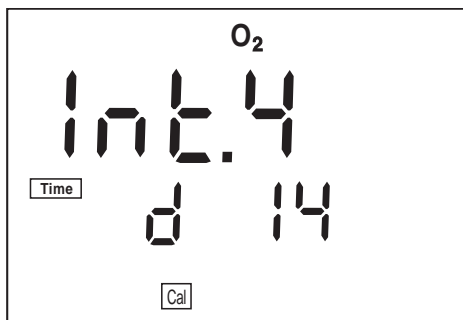

- 11 Set the required interval in days (d) with **<▲>** **<▼>**.
- 12 Confirm with **<RUN/ENTER>**. *Int 5* and the measured variable \mathcal{X} appear on the display.

Conductivity calibration interval

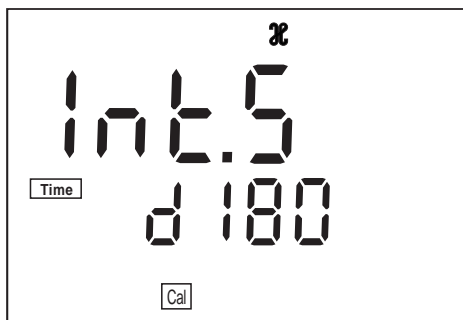

- 13 Set the required interval in days (d) with **<▲>** **<▼>**.
- 14 Confirm with **<RUN/ENTER>**. The reference temperature set for conductivity measurements appears on the display.

Switching over the reference temperature

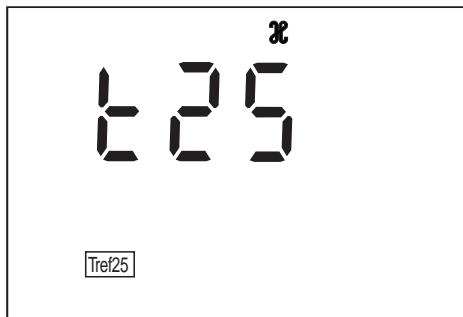

15	Using <▲> <▼>, toggle between <i>t20</i> and <i>t25</i> .
16	Confirm with <RUN/ENTER>. The date flashes on the display.

Date and time

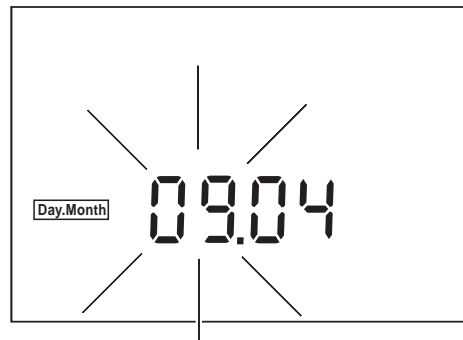

17	Set the date of the current day with <▲> <▼>.
18	Confirm with <RUN/ENTER>. The date (month) flashes in the display.
19	Set the current month with <▲> <▼>.
20	Confirm with <RUN/ENTER>. The year appears on the display.
21	Set the current year with <▲> <▼>.
22	Confirm with <RUN/ENTER>. The hours flash on the display.
23	Set the current time with <▲> <▼>.
24	Confirm with <RUN/ENTER>. The minutes flash on the display.
25	Set the current time with <▲> <▼>.
26	Confirm with <RUN/ENTER>. The measuring instrument switches to the last active measuring mode.

4.9 Reset

You can reset (initialize) the measurement parameters and the configuration parameters separately from one another.

Measurement parameters

The following measuring parameters (pH/O₂/Cond InI) can be reset to the default condition:

pH	Measuring mode	pH
	Asymmetry	0 mV
	Slope	-59.16 mV
O ₂	Measuring mode	D. O. concentration
	Relative slope	1.00
	Salinity (value)	0.0
	Salinity (function)	Off
Cond	Measuring mode	∅
	Cell constant	0.475 cm ⁻¹ (fixed)



Note

The calibration data gets lost when the measuring parameters are reset. Recalibrate after performing a reset.

Configuration parameters

The following configuration parameters (InI) are reset to the delivery status:

Baud rate	4800
Display during the pH calibration	Buffer nominal value
Interval 1 (automatically saved)	OFF
Interval 2 (for data transmission)	OFF

Resetting the measuring parameters

- 1 Press the **<RUN/ENTER>** key and hold it down.
- 2 Press the **<CAL>** key. The setting to reset the pH measuring parameters appears on the display.

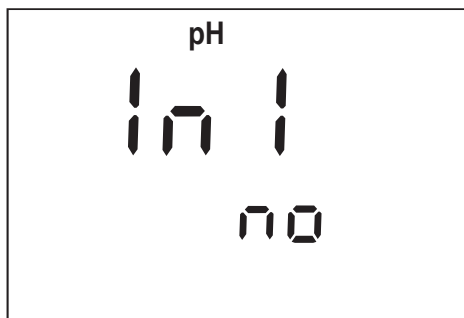

- 3 Using **<▲>** **<▼>**, switch between *no* and *YES*.
YES: Resetting the pH measuring parameters
no: Retaining settings.
- 4 Confirm with **<RUN/ENTER>**.
 The measuring instrument switches to the setting to reset the O₂ measuring parameters.

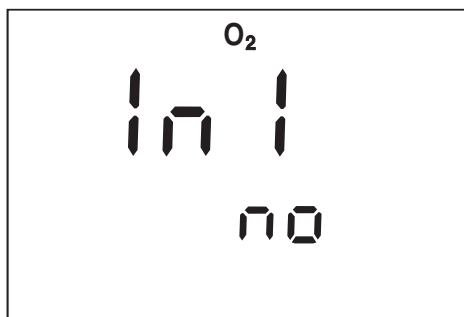

- 5 Using **<▲>** **<▼>**, switch between *no* and *YES*.
YES: Resetting the O₂ measuring parameters.
no: Retaining settings.
- 6 Confirm with **<RUN/ENTER>**. The measuring instrument switches to the setting to reset the Cond measuring parameters.

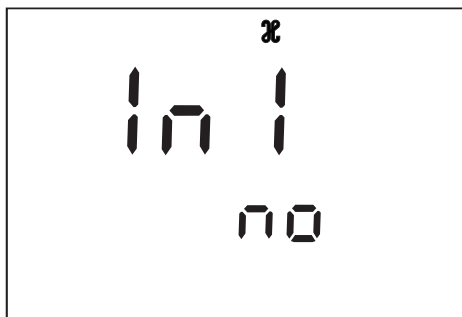

7 Using <▲> <▼>, switch between *no* and *YES*.
YES: Resetting the Cond measuring parameters.
no: Retaining settings.

8 Confirm with <RUN/ENTER>.
 The measuring instrument switches to the configuration parameters.

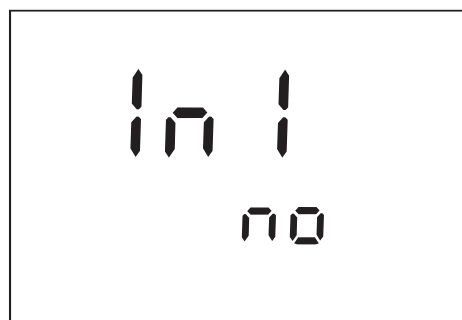

Resetting the configuration parameters

9 Using <▲> <▼>, switch between *no* and *YES*.
YES: Resetting the configuration parameters
no: Retaining settings.

10 Confirm with <RUN/ENTER>.
 The measuring instrument switches to the last active measuring mode.

5 Maintenance, cleaning, disposal

5.1 Maintenance

The measuring instrument is almost maintenance-free. The only maintenance task is replacing the batteries. *LoBat* indicates that the batteries should be changed. The batteries are then largely depleted.

Replacing the batteries

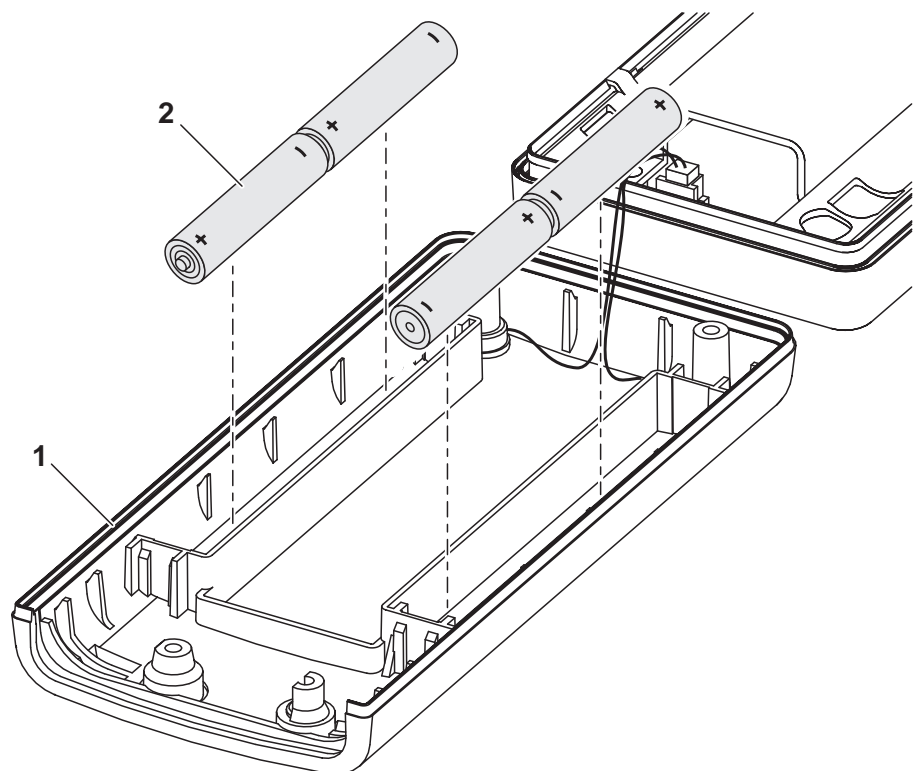

1	Open the housing after the instrument has been switched off: – Undo the four screws on the underside of the instrument – Pull down the lower cover (1).
2	If necessary, take the four depleted batteries (2) out of the battery compartment.
3	Place four new batteries (type Mignon AA) in the battery compartment.
4	Close the lower cover (1).



Warning

Make sure that the poles of the batteries are the right way round. The \pm signs on the batteries must correspond to the \pm signs in the battery compartment. Only use leakproof alkaline manganese batteries.

**Note**

For maintenance of electrodes, probes and measuring cells refer to the relevant operating manuals.

5.2 Cleaning

Occasionally wipe the outside of the measuring instrument with a damp, lint-free cloth. Disinfect the housing with isopropanol as required.

**Warning**

The housing is made of a synthetic material (ABS). Thus, avoid contact with acetone and similar detergents that contain solvents. Remove any splashes immediately.

5.3 Disposal**Packing**

This measuring instrument is sent out in a protective transport packing. We recommend: Keep the packing material. The original packing protects the instrument against damage during transport.

Batteries

This note refers to the battery regulation that applies in the Federal Republic of Germany. We would ask end-consumers in other countries to follow their local statutory provisions.

**Note**

This instrument contains batteries. Batteries that have been removed must only be disposed of at the recycling facility set up for this purpose or via the retail outlet.

It is illegal to dispose of them in household refuse.

Measuring instrument,

Dispose of the measuring instrument as electronic waste at an appropriate collection point. It is illegal to dispose of the instrument in household refuse.

6 What to do if...

6.1 pH system messages

Error message OFL

Cause	Remedy
pH electrode:	
– Not connected	– Connect electrode
– Air bubble in front of the diaphragm	– Remove air bubble
– Air in the diaphragm	– Extract air or moisten diaphragm
– Cable broken	– Replace electrode
– Gel electrolyte dried out	– Replace electrode

Error message E3

Cause	Remedy
Electrode	
– Diaphragm contaminated	– Clean diaphragm
– Membrane contaminated	– Clean membrane
– Moisture in the plug	– Dry plug
– Electrolyte out of date	– Replenish electrolyte or replace electrode
– Electrode worn out	– Replace electrode
– Electrode broken	– Replace electrode
Measuring instrument:	
– Incorrect calibration procedure	– Select correct procedure
– Incorrect solution temperature (without temperature sensor)	– Set up correct temperature
– Socket damp	– Dry socket

	Buffer solutions	
	– Incorrect buffer solutions	– Change calibration procedure
	– Buffer solutions too old	– Use only once. Note the shelf life
	– Buffer solutions depleted	– Change solutions
No stable measured value	Cause	Remedy
	pH electrode:	
	– Diaphragm contaminated	– Clean diaphragm
	– Membrane contaminated	– Clean membrane
	Test sample:	
	– pH value not stable	– Measure with air excluded if necessary
	– Temperature not stable	– Adjust temperature if necessary
	Electrode + test sample:	
	– Conductivity too low	– Use suitable electrode
	– Temperature too high	– Use suitable electrode
	– Organic liquids	– Use suitable electrode
	Obviously incorrect measured values	Cause
pH electrode:		
– pH electrode unsuitable		– Use suitable electrode
– Temperature difference between buffer and test sample too high		– Adjust temperature of buffers or sample
– Measurement procedure not suitable	– Follow special procedure	

6.2 Oxi system messages

Error message OFL

Cause	Remedy
Display range exceeded	
Oxygen sensor	
– Not connected	– Connect the probe
– Cable broken	– Replace probe
– Depleted	– Replace probe
– Short-circuit between gold and lead electrode	– Clean probe and replace it if necessary

Error message E3

Cause	Remedy
Invalid calibration	
Oxygen sensor	
– Electrolyte solution depleted	– Regenerate probe
– Membrane contaminated	– Clean membrane
– Electrode system poisoned	– Regenerate probe
– Worn out	– Replace probe
– broken	– Replace probe

Error message E7

Cause	Remedy
Membrane damaged	
– Membrane damaged	– Regenerate probe
– Membrane head not screwed on tight enough	– Screw membrane head tight

AR flashes continuously

Cause	Remedy
No stable measured value	
– Membrane contaminated	– Clean membrane

Measured value too low

Cause	Remedy
– Insufficient flow	– Provide flow to the probe

Measured value too high

Cause	Remedy
– High amount of dissolved substances	– Correct solubility function using the salinity equivalent
– Air bubbles bump on the membrane with high velocity	– Avoid direct flow to the membrane
– The carbon dioxide pressure is too high (> 1 bar)	– Measuring not possible

6.3 Conductivity system messages**Error message OFL**

Cause	Remedy
The measured value lies outside the measuring range	
– Measuring cell not connected	– Connect measuring cell
– Cable broken	– Replace measuring cell

Error message E3

Cause	Remedy
– Measuring cell contaminated	– Clean cell and replace it if necessary
– Unsuitable calibration solution	– Check calibration solutions

6.4 General errors

Display LoBat	Cause	Remedy
	– Batteries almost empty	– Exchange the batteries (see section 5.1 MAINTENANCE)
Instrument does not react to keystroke	Cause	Remedy
	– Operating condition undefined or EMC load unallowed	– Processor reset: Hold the <CAL> key depressed and switch the instrument on
Display tO	Cause	Remedy
	– Time-out of the interface	– Check that the instrument is connected
Probe symbol flashes	Cause	Remedy
	– Calibration interval expired	– Recalibrate the measuring system
Message StoFull	Cause	Remedy
	– All memory locations are full	– Output data storage and clear data storage

7 Technical data

Dimensions and weight	Length [mm]	172	
	Width [mm]	80	
	Height [mm]	37	
	Weight [kg]	Approx. 0.3	
Mechanical structure	Type of protection	IP 66	
Electrical safety	Protective class	III	
Ambient conditions	Storage	- 25 °C ... + 65 °C	
	Operation	-10 °C ... + 55 °C	
	Climatic class	2	
pH/ORP measuring ranges		Measuring range	Resolution
	pH	- 2.00 ... + 19.99	0.01
	U [mV]	- 1999 ... + 1999	1
	T [°C]	- 5.0 ... + 105.0	0.1
Precision of pH/ORP (± 1 digit)	pH (± 2 pH units around the calibration point)	± 0.03	
	U [mV]	± 1	
	T [°C]	± 0.1	
Temperature input			
	Manually [°C]	- 20 ... + 130	

Oxi measuring ranges

	mg/l	%
Measuring range I	0 ... 19.99	0 ... 199.9
Resolution	0.01	0.1
Measuring range II	0 ... 90.0l	0 ... 600
Resolution	0.1	1

Measuring range/resolution temperature

	°C
Measuring range (Resolution)	0 ... 50.0 (0.1)

Precision of Oxi (± 1 digit)

Concentration	± 0.5 % of measured value at ambient temperature of 5 °C ... 30 °C
Saturation	± 0.5 % of measured value when measuring in the range of ± 10 K around the calibration temperature
Temperature compensation	< 2 % at 0 ... 40 °C
T [°C]	± 0.1

Correction functions of Oxi

Salinity correction	0 ... 70.0 SAL
Air pressure correction	automatic through built-in pressure sensor in the range 500 ... 1100 mbar

Cond measuring ranges

	Measuring range	Resolution
κ [μS/cm]	0 ... 1999	1
κ [mS/cm]	0.00 ... 19.99	0.01
	0.0 ... 199.9	0.1
	0 ... 500	1
SAL	0.0 ... 70.0 accord- ing to the IOT table	0.1
T [°C]	- 5.0 ... + 105.0	0.1

Precision of Cond (± 1 digit)	∞	Nonlinear compensation <input type="checkbox"/> nLF Accuracy Sample temperature ± 0.5 % 0 °C ... 35 °C ± 0.5 % 35 °C ... 50 °C extended nLF function acc. to WTW measurements
	SAL	Range 0.0 ... 42.0 Accuracy Sample temperature ± 0.1 5 °C ... 25 °C ± 0.2 25 °C ... 30 °C
	T [°C]	± 0.1
Cell constant, calibrating	C [cm ⁻¹]	0.450 ... 0.500
Cond reference temperature	Tref	Can be set to 20 °C or 25 °C
Serial interface	Connection of the cable AK 340/B, AK 325/S	
	Type	RS232, data output
	Baud rate	Can be set to 1200, 2400, 4800, 9600 Baud
	Data bits	8
	Stop bits	2
	Parity	None
	Handshake	RTS/CTS + Xon/Xoff
	Cable length	Max. 15m

Power supply	Batteries	4 x 1.5 V alkali-manganese batteries, Type AA
	Operational life	Approx. 3000 operating hours
	Mains	<p>The following applies to all plug-in power supplies: Connection max. Overvoltage category II</p> <p>Plug-in power supply unit (Euro, US , UK, Australian plug) FRIWO FW7555M/09, 15.1432 Friwo Part. No. 1822089 Input: 100 ... 240 V ~ / 50 ... 60 Hz / 400 mA Output: 9 V = / 1,5 A</p> <p>Plug-in power supply with Euro plug: FRIWO FW1199, 11.7864 Friwo Part. No. 1762613 Input: 230 V ~ / 50 Hz / 5.6 VA Output: 12 V = / 130 mA / 1.56 VA</p> <p>Plug-in power supply with US plug: FRIWO FW1199, 11.7880 Friwo Part. No. 1794043 Input: 120 V ~ / 60 Hz / 6 VA Output: 12 V = / 150 mA</p> <p>Plug-in power supply with UK plug: FRIWO FW1199, 11.7872 Friwo Part No. 1816491 Input: 230V ~ / 50 Hz / 5.6 VA Output: 12 V = / 130 mA / 1.56 VA</p>
Guidelines and norms used	EMC	E.C. guideline 89/336/EEC EN 61326-1:1997 EN 61000-3-2 A14:2000 EN 61000-3-3:1995 FCC Class A
	Instrument safety	E.C. guideline 73/23/EEC EN 61010-1 A2:1995
	Climatic class	VDI/VDE 3540
	IP protection class	EN 60529:1991

FCC Class A Equipment Statement

Note: This equipment has been tested and found to comply with the limits for a Class A digital device, pursuant to Part 15 of the FCC Rules. These limits are designed to provide reasonable protection against harmful interference when the equipment is operated in a commercial environment. This equipment generates, uses, and can radiate radio frequency energy and, if not installed and used in accordance with the instruction manual, may cause harmful interference to radio communications. Operation of this equipment in a residential area is likely to cause harmful interference in which case the user will be required to correct the interference at his own expense.

Test certificates cETLus, CE

8 Lists

This chapter provides additional information and orientation aids.

Abbreviations

The list of abbreviations explains the indicators and the abbreviations that appear on the display and in the manual.

Specialist terms

The glossary briefly explains the meaning of the specialist terms. However, terms that should already be familiar to the target group are not described here.

Index

The index will help you to find the topics that you are looking for.

Abbreviations

κ	Conductivity value (international γ)
AR	AutoRead (drift control)
ARng	Automatic range switching Measuring instrument measures with highest resolution
ASY	Asymmetry
AutoCal DIN	Automatic pH calibration with buffer solutions prepared according to DIN 19 266
AutoCal TEC	Automatic pH calibration with WTW technical buffer solutions according to DIN 19267
C	Cell constant [cm^{-1}] (internat. k)
$^{\circ}\text{C}$	Temperature unit, degrees Celsius
Cal	Calibration
Cd...	Display indicator during calibration for pH measurements. Indicates the selection of the buffer data record for buffer solutions prepared according to DIN 19 266
Cm...	Display indicator during calibration for pH measurements. Indicates the selection of buffer data records for buffer solutions of the Merck company
ConCal	Conventional single-point or two-point calibration for pH measurements
Ct...	Display indicator during calibration for pH measurements. Indicates the selection of the buffer data records for WTW technical buffer solutions
E3	Error message see chapter 6 WHAT TO DO IF...
InI	Initialization Resets individual basic functions to the status they had on delivery
LoBat	Batteries almost empty (Low Battery)
mV	Voltage unit
mV/pH	Unit of the electrode slope (internat. mV)

nLF	Nonlinear temperature compensation
OFL	Display range exceeded (Overflow)
OxiCal	Automatic calibration for D. O. measurements
pH	pH value
S	Slope (internat. k)
SAL	Salinity
SELV	Safety Extra Low Voltage
SLO	Slope setting on calibration
TC	Temperature coefficient (internat. α)
TP	Temperature measurement active (temperature sensor)
T _{Ref 25/T25}	Reference temperature of 25 °C
U _{ASY}	Asymmetry

Glossary

Adjusting	To manipulate a measuring system so that the relevant value (e. g. the displayed value) differs as little as possible from the correct value or a value that is regarded as correct, or that the difference remains within the tolerance.
Asymmetry	Designation for the offset potential of a pH electrode. It is the measurable potential of a symmetrical electrode, the membrane of which is immersed in a solution with the pH of the nominal electrode zero point (WTW electrodes: pH = 7).
AutoRange	Name of the automatic selection of the measuring range.
AutoRead	WTW name for a function to check the stability of the measured value.
Calibration	Comparing the value from a measuring system (e. g. the displayed value) to the correct value or a value that is regarded as correct. Often, this expression is also used when the measuring system is adjusted at the same time (see adjusting).
Cell constant, k	Characteristic quantity of a conductivity measuring cell, depending on the geometry.
Conductivity	Short form of the expression, specific electrical conductivity. It is a measured value of the ability of a substance to conduct an electric current. In water analysis, the electrical conductivity is a dimension for the ionized substances in a solution.
D. O. partial pressure	Pressure caused by the oxygen in a gas mixture or liquid.
Diaphragm	The junction is a porous body in the housing wall of reference electrodes or electrolyte bridges. It forms the electrical contact between two solutions and makes electrolyte exchange more difficult. The expression, junction, is also used for ground or junction-less transitions.
Electrode zero point	The zero point of a pH electrode is the pH value at which the electromotive force of the pH electrode at a specified temperature is zero. Normally, this is at 25 °C.
Electromotive force of an electrode	The electromotive force U of the electrode is the measurable electromotive force of an electrode in a solution. It equals the sum of all the galvanic voltages of the electrode. Its dependency on the pH results in the electrode function which is characterized by the parameters, slope and zero point.
Measured parameter	The measured parameter is the physical dimension determined by measuring, e. g. pH, conductivity or D. O. concentration.
Measured value	The measured value is the special value of a measured parameter to be determined. It is given as a combination of the numerical value and unit (e. g. 3 m; 0.5 s; 5.2 A; 373.15 K).

Measuring system	The measuring system comprises all the devices used for measuring, e. g. measuring instrument and probe. In addition, there is the cable and possibly an amplifier, terminal strip and armature.
Molality	Molality is the quantity (in Mol) of a dissolved substance in 1000 g solvent.
MultiCal®	WTW name stating that a measuring instrument provides several calibration procedures.
Offset potential	The measurable potential of a symmetrical electrode, the membrane of which is immersed in a solution with the pH of the nominal electrode zero point. The asymmetry is part of the offset potential.
ORP voltage	The ORP is caused by oxidizing or reducing substances dissolved in water if these substances become effective on an electrode surface (e. g. a gold or platinum surface).
OxiCal®	WTW name for a procedure to calibrate D. O. measuring systems in water vapor saturated air.
Oxygen saturation	Short name for the relative D. O. saturation. Note: The D. O. saturation value of air-saturated water and the D. O. saturation value of oxygen-saturated water are different.
pH value	The pH is a measure of the acidic or basic effect of an aqueous solution. It corresponds to the negative decadic logarithm of the molal hydrogen ions activity divided by the unit of the molality. The practical pH value is the value of a pH measurement.
Potentiometry	Name of a measuring technique. The signal (depending on the measured parameter) of the electrode is the electrical potential. The electrical current remains constant.
Reference temperature	Fixed temperature value to compare temperature-dependent measured values. For conductivity measurements, the measured value is converted to a conductivity value at a reference temperature of 20 °C or 25 °C.
Reset	Restoring the original condition of all settings of a measuring system.
Resistance	Short name for the specific electrolytic resistance. It corresponds to the reciprocal value of the electrical conductivity.
Resolution	Smallest difference between two measured values that can be displayed by a measuring instrument.
Salinity	The absolute salinity S_A of seawater corresponds to the relationship of the mass of dissolved salts to the mass of the solution (in g/Kg). In practice, this dimension cannot be measured directly. Therefore, the practical salinity is used for oceanographic monitoring. It is determined by measuring the electrical conductivity.

Salt content	General designation for the quantity of salt dissolved in water.
Sample	Designation of the sample ready to be measured. Normally, a test sample is made by processing the original sample. The test sample and original sample are identical if the test sample was not processed.
Setting the temperature compensation	Name of a function that considers the temperature influence on the measurement and converts it accordingly. Depending on the measured parameter to be determined, the temperature compensation functions in different ways. For conductimetric measurements, the measured value is converted to a defined reference temperature. For potentiometric measurements, the slope value is adjusted to the temperature of the test sample but the measured value is not converted.
Slope	The slope of a linear calibration function.
Slope (relative)	Designation used by WTW in the D. O. measuring technique. It expresses the relationship of the slope value to the value of a theoretical reference probe of the same type of construction.
Standard solution	The standard solution is a solution where the measured value is known by definition. It is used to calibrate a measuring system.
TDS	Total dissolved solids
Temperature coefficient	Value of the slope of a linear temperature function.
Temperature function	Name of a mathematical function expressing the temperature behavior of a test sample, a probe or part of a probe.

Index**A**

Air pressure display 57
Asymmetry 20
Authorized use 11
AutoCal TEC 20, 22
AutoRange (oxygen) 15
AutoRead
 Conductivity 37
 D. O. 29
 pH 18

C

Calibration
 Conductivity 38
 D. O. 30
 pH 20
Calibration evaluation
 D. O. 31
 Dissolved oxygen 31
Calibration interval 41
 conductivity 58
 Dissolved oxygen 58
 pH 57
Calibration protocol 20
 conductivity 38
 D. O. 30
Cell constant 35, 38
Conductivity calibration
 evaluation 39
Configuration parameters 60
Connecting a printer 55

D

D. O.
 Measuring the concentra-
 tion 27
 Measuring the saturation
 28
Data record 42
Default condition 60
Display 9
Drift control
 Conductivity 37
 D. O.
 29
 pH 18

E

Energy saving feature 15
Error messages 67, 68

I

Initial commissioning 13
Initialization 60
Interval
 Calibration (Int 3) 41
 save 44

J

Jack field 9

K

Keys 8

M

Measuring 34
 conductivity 36
 D. O. concentration 27
 D. O. saturation 28
 ORP voltage 19
 pH value 18
 Salinity 36
Measuring mode when
 switching on 15
Measuring ranges
 Conductivity 72
 oxygen 72
 pH/ORP 71
Measuring ranges with
 DurOx 72
Measuring the conductivity
 36
Measuring the salinity 36

O

Operating 10
Operating safety 12
ORP electrode 19
ORP voltage 19
Oxygen
 Measurement range sel-
 ection 15

P

pH calibration evaluation 21
pH value 18
Plug-in power supply 14
Precautions 11

R

Reference temperature
 (conductivity) 34
Remote control 55
Replacing the batteries 63
Reset 60
Resetting the measuring
 parameters 61
RS232 interface 55
RS232 socket assignment
 55

S

Safety 11
Salt content correction
 entering the salinity 33
 switching on 27
Save interval 44
Saving data 42
Scope of delivery 13
Setting the baud rate 56
Setting the date 13, 59
Setting the reference
 temperature 58
Setting the time 13, 59
Single-point calibration (pH)
 20, 23
Slope 20, 30

T

Temperature compensation
 (conductivity) 34
Temperature probe
 Conductivity 34
Temperature sensor
 D. O. 26
 pH 17
Transmitting data 53
Transmitting measured

values 53

Two-point calibration (pH)

20, 23