

# **GA-8S661FXM-775**

Intel® Pentium® 4 LGA775 Processor Motherboard

## **User's Manual**

Rev. 1102

12ME-61FXM775-1102



## **Copyright**

© 2006 GIGA-BYTE TECHNOLOGY CO., LTD. All rights reserved.

The trademarks mentioned in the manual are legally registered to their respective companies.

## **Notice**

The written content provided with this product is the property of Gigabyte.

No part of this manual may be reproduced, copied, translated, or transmitted in any form or by any means without Gigabyte's prior written permission. Specifications and features are subject to change without prior notice.

## **Product Manual Classification**

In order to assist in the use of this product, Gigabyte has categorized the user manual in the following:

- For detailed product information and specifications, please carefully read the "User's Manual."
  
- For detailed information related to Gigabyte's unique features, please go to the "Technology Guide" section on Gigabyte's website to read or download the information you need.

For more product details, please visit Gigabyte's website at [www.gigabyte.com.tw](http://www.gigabyte.com.tw)

# Table of Contents

GA-8S661FXM-775 Motherboard Layout .....	6
Block Diagram .....	7
Chapter 1 Hardware Installation .....	9
1-1 Considerations Prior to Installation .....	9
1-2 Feature Summary .....	10
1-3 Installation of the CPU and Heatsink .....	12
1-3-1 Installation of the CPU .....	12
1-3-2 Installation of the Heatsink .....	13
1-4 Installation of Memory .....	14
1-5 Installation of Expansion Cards .....	15
1-6 I/O Back Panel Introduction .....	16
1-7 Connectors Introduction .....	17
Chapter 2 BIOS Setup .....	29
The Main Menu (For example: BIOS Ver. : E3) .....	30
2-1 Standard CMOS Features .....	32
2-2 Advanced BIOS Features .....	34
2-3 Integrated Peripherals .....	36
2-4 Power Management Setup .....	38
2-5 PnP/PCI Configurations .....	40
2-6 PC Health Status .....	41
2-7 MB Intelligent Tweaker (M.I.T.) .....	42
2-8 Top Performance .....	44
2-9 Load Fail-Safe Defaults .....	44
2-10 Load Optimized Defaults .....	45
2-11 Set Supervisor/User Password .....	45
2-12 Save & Exit Setup .....	46
2-13 Exit Without Saving .....	46

Chapter 3 Drivers Installation .....	49
3-1 Install Chipset Drivers .....	49
3-2 Software Applications .....	50
3-3 Driver CD Information .....	50
3-4 Hardware Information .....	51
3-5 Contact Us .....	51
Chapter 4 Appendix .....	53
4-1 Unique Software Utility .....	53
4-1-1 Xpress Recovery2 Introduction .....	53
4-1-2 BIOS Flash Method Introduction .....	55
4-1-3 Serial ATA BIOS Setting Utility Introduction .....	64
4-1-4 2 / 4 / 6 Channel Audio Function Introduction .....	71
4-2 Troubleshooting .....	79

# GA-8S661FXM-775 Motherboard Layout

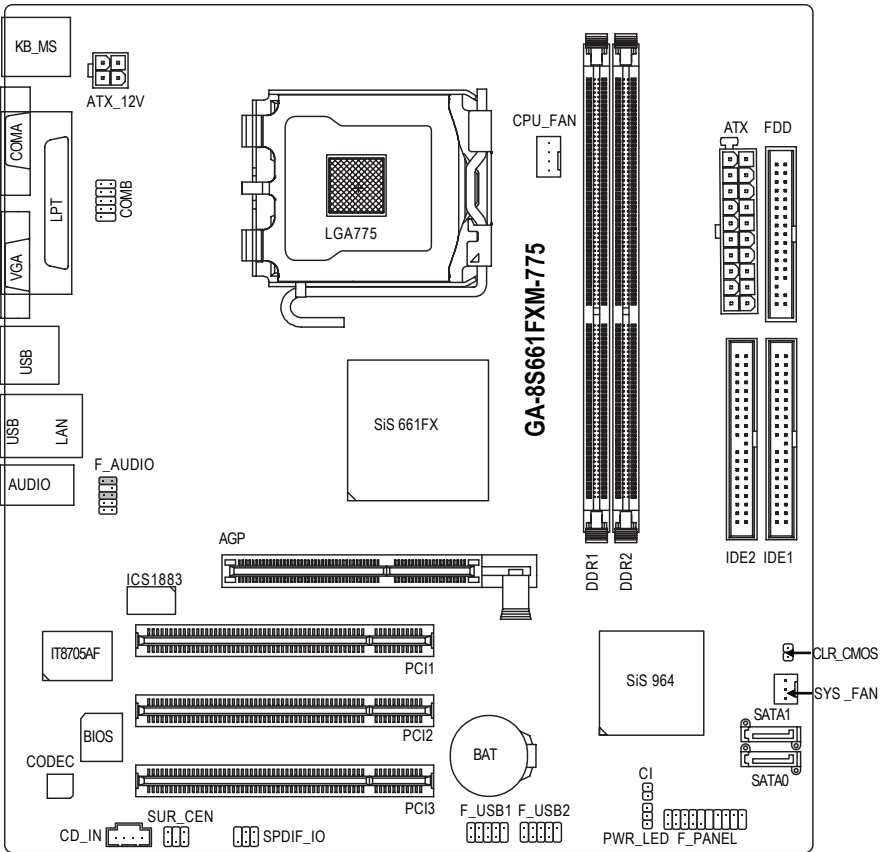

# Block Diagram

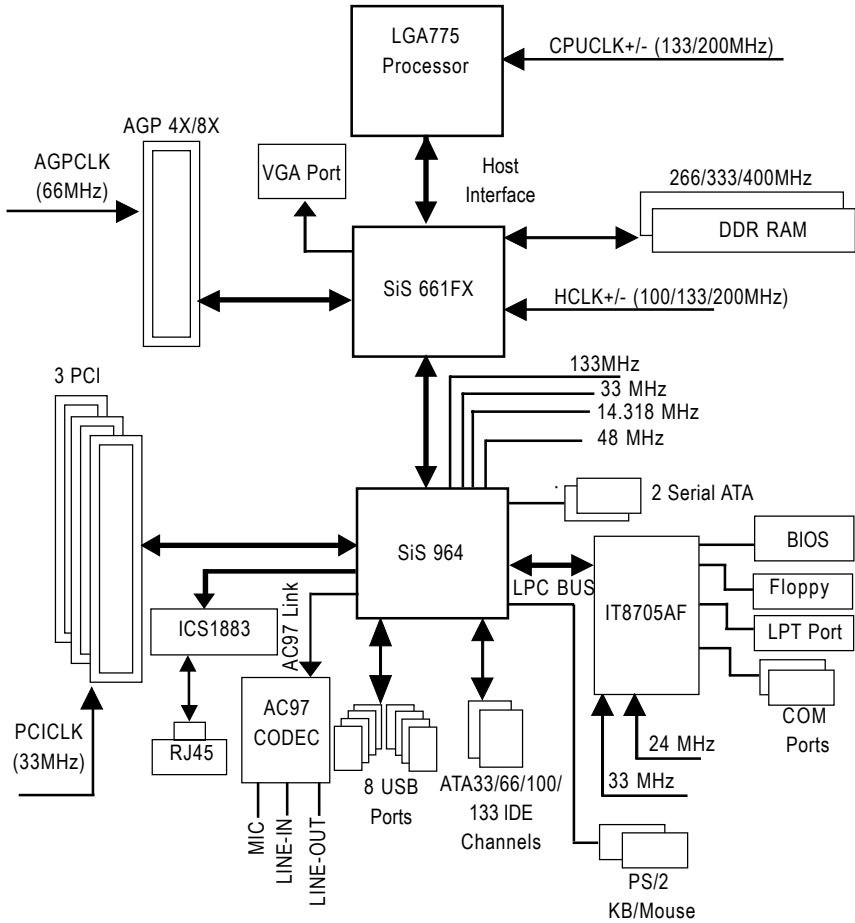





# Chapter 1 Hardware Installation

## 1-1 Considerations Prior to Installation

### Preparing Your Computer

The motherboard contains numerous delicate electronic circuits and components which can become damaged as a result of electrostatic discharge (ESD). Thus, prior to installation, please follow the instructions below:

1. Please turn off the computer and unplug its power cord.
2. When handling the motherboard, avoid touching any metal leads or connectors.
3. It is best to wear an electrostatic discharge (ESD) cuff when handling electronic components (CPU, RAM).
4. Prior to installing the electronic components, please have these items on top of an antistatic pad or within a electrostatic shielding container.
5. Please verify that the power supply is switched off before unplugging the power supply connector from the motherboard.

### Installation Notices

1. Prior to installation, please do not remove the stickers on the motherboard. These stickers are required for warranty validation.
2. Prior to the installation of the motherboard or any hardware, please first carefully read the information in the provided manual.
3. Before using the product, please verify that all cables and power connectors are connected.
4. To prevent damage to the motherboard, please do not allow screws to come in contact with the motherboard circuit or its components.
5. Please make sure there are no leftover screws or metal components placed on the motherboard or within the computer casing.
6. Please do not place the computer system on an uneven surface.
7. Turning on the computer power during the installation process can lead to damage to system components as well as physical harm to the user.
8. If you are uncertain about any installation steps or have a problem related to the use of the product, please consult a certified computer technician.

### Instances of Non-Warranty

1. Damage due to natural disaster, accident or human cause.
2. Damage as a result of violating the conditions recommended in the user manual.
3. Damage due to improper installation.
4. Damage due to use of uncertified components.
5. Damage due to use exceeding the permitted parameters.
6. Product determined to be an unofficial Gigabyte product.

## 1-2 Feature Summary

CPU	<ul style="list-style-type: none"> <li>◆ Supports the latest Intel® Pentium® 4 LGA775 CPU</li> <li>◆ Supports 800/533MHz FSB</li> <li>◆ L2 cache varies with processors</li> </ul>
Chipset	<ul style="list-style-type: none"> <li>◆ Northbridge: SiS® 661FX</li> <li>◆ Southbridge: SiS® 964</li> </ul>
Memory	<ul style="list-style-type: none"> <li>◆ 2 184-pin DDR DIMM slots</li> <li>◆ Supports DDR400/333/266 DIMM</li> <li>◆ Supports up to 2GB (Max.)</li> </ul>
Slots	<ul style="list-style-type: none"> <li>◆ 1 AGP slot 4X/8X (1.5V) device support</li> <li>◆ 3 PCI slots</li> </ul>
IDE Connections	<ul style="list-style-type: none"> <li>◆ 2 IDE connection (UDMA 33/ATA 66/ATA 100/ATA133), allows connection of 4 IDE devices</li> </ul>
Onboard SATA	<ul style="list-style-type: none"> <li>◆ 2 Serial ATA ports</li> </ul>
FDD Connections	<ul style="list-style-type: none"> <li>◆ 1 FDD connection, allows connection of 2 FDD devices</li> </ul>
Peripherals	<ul style="list-style-type: none"> <li>◆ 1 parallel port supporting Normal/EPP/ECP mode</li> <li>◆ 1 VGA port, 1 COMA port, onboard COMB connection</li> <li>◆ 8 USB 2.0/1.1 ports (rear x 4, front x 4 via cable)</li> <li>◆ 1 front audio connector</li> <li>◆ 1 PS/2 keyboard port</li> <li>◆ 1 PS/2 mouse port</li> </ul>
Onboard VGA	<ul style="list-style-type: none"> <li>◆ Built-in SiS® 661FX Chipset</li> </ul>
Onboard LAN	<ul style="list-style-type: none"> <li>◆ ICS 1883 chip</li> <li>◆ 1 RJ45 port</li> </ul>
Onboard Audio	<ul style="list-style-type: none"> <li>◆ Realtek ALC655 CODEC</li> <li>◆ Supports Line In ; Line Out ; MIC In</li> <li>◆ Supports 2 / 4 / 6 channel audio</li> <li>◆ SPDIF In/Out connection</li> <li>◆ CD In connection</li> <li>◆ Supports Jack-Sensing function</li> </ul>
I/O Control	<ul style="list-style-type: none"> <li>◆ IT8705AF</li> </ul>
Hardware Monitor	<ul style="list-style-type: none"> <li>◆ CPU / System fan speed detection</li> <li>◆ System voltage detection</li> <li>◆ CPU temperature detection</li> <li>◆ CPU Smart Fan Control</li> </ul>

---

Onboard SATA RAID	<ul style="list-style-type: none"><li>◆ Onboard SiS964 chipset<ul style="list-style-type: none"><li>- supports data striping (RAID 0) or mirroring (RAID 1) function</li><li>- supports JBOD function</li><li>- supports data transfer rate of up to 150 MB/s</li><li>- supports hot plugging function</li><li>- supports a maximum of 2 SATA connections</li></ul></li></ul>
BIOS	<ul style="list-style-type: none"><li>◆ Use of licensed AWARD BIOS</li><li>◆ Supports Q-Flash</li></ul>
Additional Features	<ul style="list-style-type: none"><li>◆ Supports @BIOS</li><li>◆ Supports EasyTune</li></ul>
Form Factor	<ul style="list-style-type: none"><li>◆ Micro-ATX form factor; 24.4cm x 23.0cm</li></ul>

---

## 1-3 Installation of the CPU and Heatsink



CAUTION

Before installing the CPU, please comply with the following conditions:

1. Please make sure that the motherboard supports the CPU.
2. Please take note of the one indented corner of the CPU. If you install the CPU in the wrong direction, the CPU will not insert properly. If this occurs, please change the insert direction of the CPU.
3. Please add an even layer of heat sink paste between the CPU and heatsink.
4. Please make sure the heatsink is installed on the CPU prior to system use, otherwise overheating and permanent damage of the CPU may occur.
5. Please set the CPU host frequency in accordance with the processor specifications. It is not recommended that the system bus frequency be set beyond hardware specifications since it does not meet the required standards for the peripherals. If you wish to set the frequency beyond the proper specifications, please do so according to your hardware specifications including the CPU, graphics card, memory, hard drive, etc.



NOTE

### HT functionality requirement content :

Enabling the functionality of Hyper-Threading Technology for your computer system requires all of the following platform components:

- CPU: An Intel® Pentium 4 Processor with HT Technology
- Chipset: An SiS® Chipset that supports HT Technology
- BIOS: A BIOS that supports HT Technology and has it enabled
- OS: An operation system that has optimizations for HT Technology

### 1-3-1 Installation of the CPU

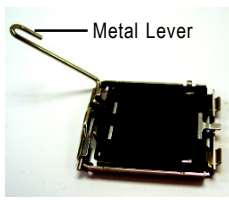

Fig. 1  
Gently lift the metal lever located on the CPU socket to the upright position.

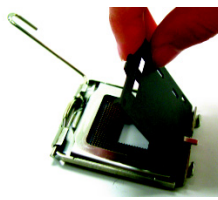

Fig. 2  
Remove the plastic covering on the CPU socket.

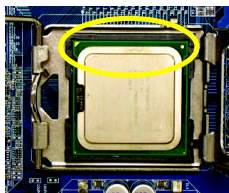

Fig. 3  
Notice the small gold colored triangle located on the edge of the CPU socket. Align the indented corner of the CPU with



Fig. 4  
Once the CPU is properly inserted, please replace the plastic covering and push the metal lever back into its original position.

the triangle and gently insert the CPU into position. (Grasping the CPU firmly between your thumb and forefinger, carefully place it into the socket in a straight and downwards motion. Avoid twisting or bending motions that might cause damage to the CPU during installation.)

### 1-3-2 Installation of the Heatsink

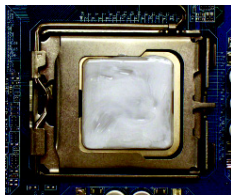

Fig. 1  
Please apply an even layer of heatsink paste on the surface of the installed CPU.

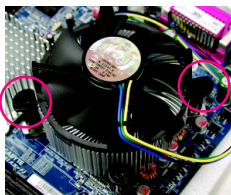

Fig. 3  
Place the heatsink atop the CPU and make sure the push pins aim to the pin hole on the motherboard. Pressing down the push pins diagonally.

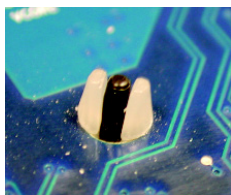

Fig. 5  
Please check the back of motherboard after installing. If the push pin is inserted as the picture, the installation is complete.

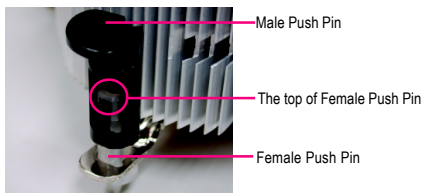

Fig. 2  
(Turning the push pin along the direction of arrow is to remove the heatsink, on the contrary, is to install.)  
Please note the direction of arrow sign on the male push pin doesn't face inwards before installation. (This instruction is only for Intel boxed fan)

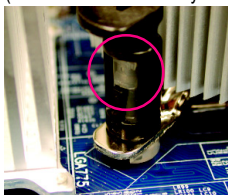

Fig. 4  
Please make sure the Male and Female push pin are joined closely. (for detailed installation instructions, please refer to the heatsink installation section of the user manual)

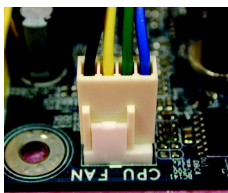

Fig. 6  
Finally, please attach the power connector of the heatsink to the CPU fan header located on the motherboard.



The heatsink may adhere to the CPU as a result of hardening of the heatsink paste. To prevent such an occurrence, it is suggested that either thermal tape rather than heat sink paste be used for heat dissipation or using extreme care when removing the heatsink.

## 1-4 Installation of Memory



Before installing the memory modules, please comply with the following conditions:

1. Please make sure that the memory used is supported by the motherboard. It is recommended that memory of similar capacity, specifications and brand be used.
2. Before installing or removing memory modules, please make sure that the computer power is switched off to prevent hardware damage.
3. Memory modules have a foolproof insertion design. A memory module can be installed in only one direction. If you are unable to insert the module, please switch the direction.

The motherboard has 2 dual inline memory module (DIMM) sockets. The BIOS will automatically detects memory type and size. To install the memory module, just push it vertically into the DIMM socket. The DIMM module can only fit in one direction due to the notch. Memory size can vary between sockets.

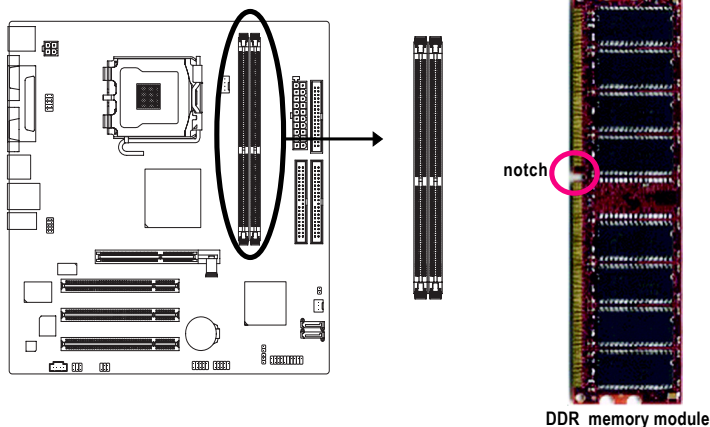

DDR memory module

Fig.1

The DIMM socket has a notch, so the DIMM memory module can only fit in one direction. Insert the DIMM memory module vertically into the DIMM socket. Then push it down.



Fig. 1

Fig.2

Close the plastic clip at both edges of the DIMM sockets to lock the DIMM module.

Reverse the installation steps when you wish to remove the DIMM module.



Fig. 2

## 1-5 Installation of Expansion Cards

You can install your expansion card by following the steps outlined below:

1. Read the related expansion card's instruction document before installing the expansion card into the computer.
2. Remove your computer's chassis cover, screws and slot bracket from the computer.
3. Press the expansion card firmly into expansion slot in motherboard.
4. Be sure the metal contacts on the card are indeed seated in the slot.
5. Replace the screw to secure the slot bracket of the expansion card.
6. Replace your computer's chassis cover.
7. Power on the computer, if necessary, setup BIOS utility of expansion card from BIOS.
8. Install related driver from the operating system.

Installing a AGP expansion card:

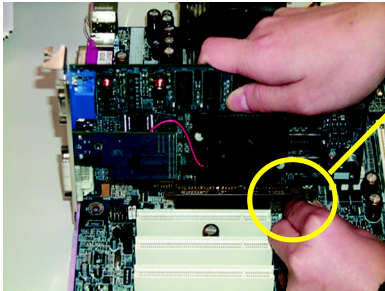

AGP Card

Please carefully pull out the small white-drawable bar at the end of the AGP slot when you try to install/uninstall the VGA card. Please align the VGA card to the onboard AGP slot and press firmly down on the slot. Make sure your VGA card is locked by the small white-drawable bar.

## 1-6 I/O Back Panel Introduction

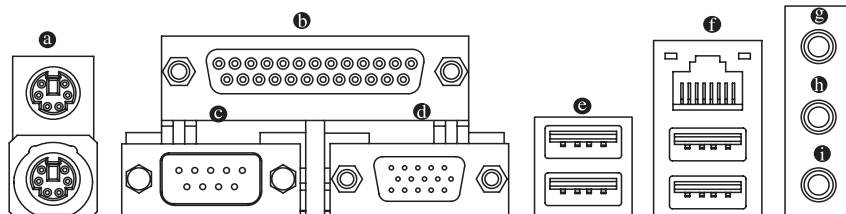

### **a PS/2 Keyboard and PS/2 Mouse Connector**

To install a PS/2 port keyboard and mouse, plug the mouse to the upper port (green) and the keyboard to the lower port (purple).

### **b Parallel Port**

The parallel port allows connection of a printer, scanner and other peripheral devices.

### **c Serial Port**

Devices like mice, modems, and etc. can be connected to Serial port.

### **d VGA Port**

Monitor can be connected to VGA port.

### **e USB port**

Before you connect your device(s) into USB connector(s), please make sure your device(s) such as USB keyboard, mouse, scanner, zip, speaker...etc. have a standard USB interface. Also make sure your OS supports USB controller. If your OS does not support USB controller, please contact OS vendor for possible patch or driver upgrade. For more information please contact your OS or device(s) vendors.

### **f LAN Port**

The LAN port provides Internet connection.

### **g Line In**

Devices like CD-ROM, walkman etc. can be connected to Line In jack.

### **h Line Out (Front Speaker Out)**

Connect the stereo speakers, earphone or front surround channels to this connector.

### **i MIC In**

Microphone can be connected to MIC In jack.



## 1-7 Connectors Introduction

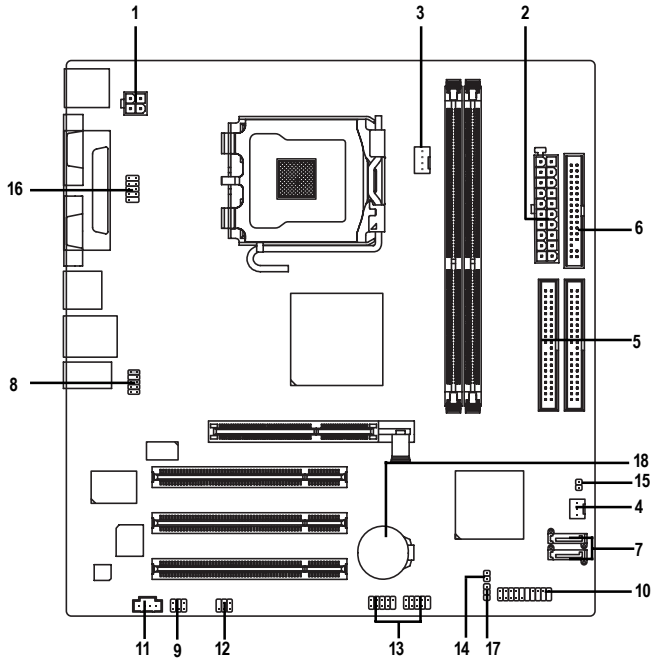

1)	ATX_12V	10)	F_PANEL
2)	ATX	11)	CD_IN
3)	CPU_FAN	12)	SPDIF_IO
4)	SYS_FAN	13)	F_USB1/F_USB2
5)	IDE1/IDE2	14)	CI
6)	FDD	15)	CLR_CMOS
7)	SATA0/SATA1	16)	COMB
8)	F_AUDIO	17)	PWR_LED
9)	SUR_CEN	18)	BAT

## 1/2) ATX\_12V/ATX (Power Connector)

With the use of the power connector, the power supply can supply enough stable power to all the components on the motherboard. Before connecting the power connector, please make sure that all components and devices are properly installed. Align the power connector with its proper location on the motherboard and connect tightly.

The ATX\_12V power connector mainly supplies power to the CPU. If the ATX\_12V power connector is not connected, the system will not start.

Caution!

Please use a power supply that is able to handle the system voltage requirements. It is recommended that a power supply that can withstand high power consumption be used (300W or greater). If a power supply is used that does not provide the required power, the result can lead to an unstable system or a system that is unable to start.

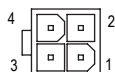
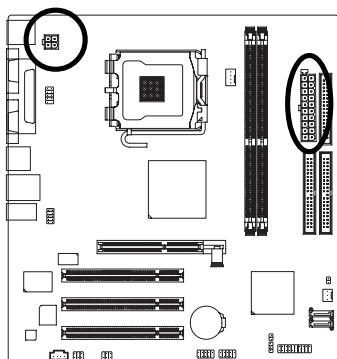

Pin No.	Definition
1	GND
2	GND
3	+12V
4	+12V

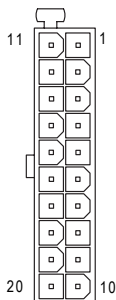

Pin No.	Definition
1	3.3V
2	3.3V
3	GND
4	VCC
5	GND
6	VCC
7	GND
8	Power Good
9	5V SB (stand by +5V)
10	+12V
11	3.3V
12	-12V
13	GND
14	PS_ON (soft on/off)
15	GND
16	GND
17	GND
18	-5V
19	VCC
20	VCC

### 3/4) CPU\_FAN / SYS\_FAN (Cooler Fan Power Connector)

The cooler fan power connector supplies a +12V power voltage via a 3-pin/4-pin (only for CPU\_FAN) power connector and possesses a fool-proof connection design.

Most coolers are designed with color-coded power connector wires. A red power connector wire indicates a positive connection and requires a +12V power voltage. The black connector wire is the ground wire (GND).

Please remember to connect the power to the cooler to prevent system overheating and failure.

Caution! Please remember to connect the power to the CPU fan to prevent CPU overheating and failure.

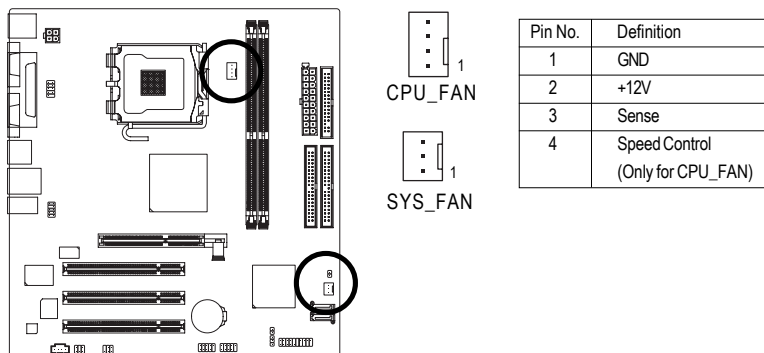

## 5) IDE1/IDE2 (IDE Connector)

An IDE device connects to the computer via an IDE connector. One IDE connector can connect to one IDE cable, and the single IDE cable can then connect to two IDE devices (hard drive or optical drive). If you wish to connect two IDE devices, please set the jumper on one IDE device as Master and the other as Slave (for information on settings, please refer to the instructions located on the IDE device).

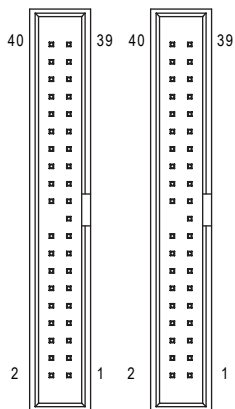
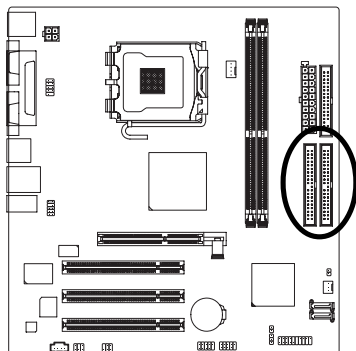

IDE2 Connector

IDE1 Connector

## 6) FDD (FDD Connector)

The FDD connector is used to connect the FDD cable while the other end of the cable connects to the FDD drive. The types of FDD drives supported are: 360KB, 720KB, 1.2MB, 1.44MB and 2.88MB. Please connect the red power connector wire to the pin1 position.

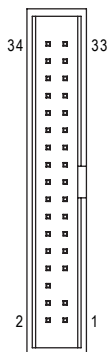
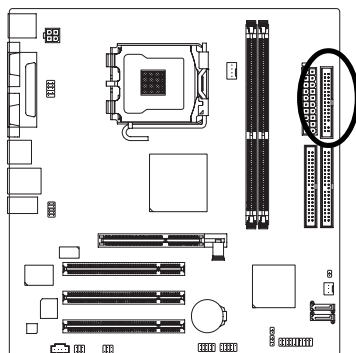

**7) SATA0/SATA1 (Serial ATA Connector, Controlled by SiS964)**

Serial ATA can provide up to 150MB/s transfer rate. Please refer to the BIOS setting for the Serial ATA and install the proper driver in order to work properly.

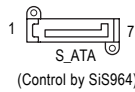
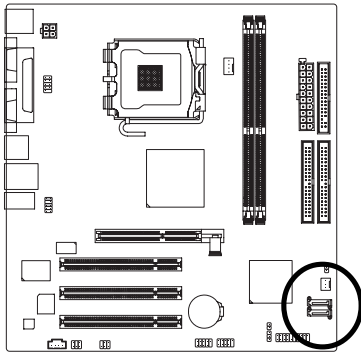

Pin No.	Definition
1	GND
2	TXP
3	TXN
4	GND
5	RXN
6	RXP
7	GND

**8) F\_AUDIO (Front Audio Panel Connector)**

Please make sure the pin assignment on the cable is the same as the pin assignment on the MB header. To find out if the chassis you are buying support front audio panel connector, please contact your dealer. If you want to use "Front Audio" connector, you must remove the jumpers from pins 5-6, 9-10.

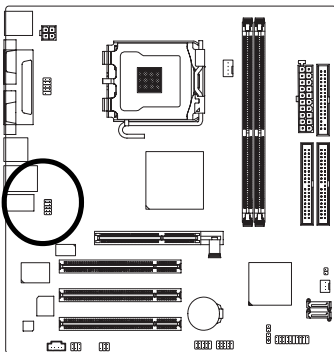

Pin No.	Definition
1	MIC
2	GND
3	MIC_BIAS
4	POWER
5	FrontAudio(R)
6	Rear Audio (R)/ Return R
7	NC
8	No Pin
9	FrontAudio (L)
10	Rear Audio (L)/ Return L

### 9) SUR\_CEN

Please contact your nearest dealer for optional SUR\_CEN cable.

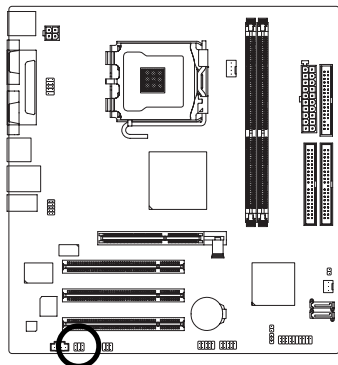

Pin No.	Definition
1	SUR OUTL
2	SUR OUTR
3	GND
4	No Pin
5	CENTER_OUT
6	BASS_OUT

### 10) F\_PANEL (Front Panel Connector)

Please connect the power LED, PC speaker, reset switch and power switch etc. of your chassis front panel to the F\_PANEL connector according to the pin assignments below.

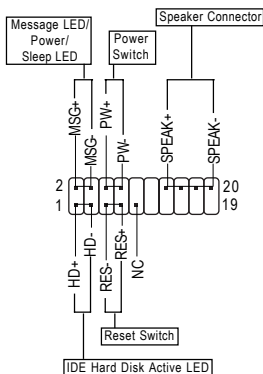
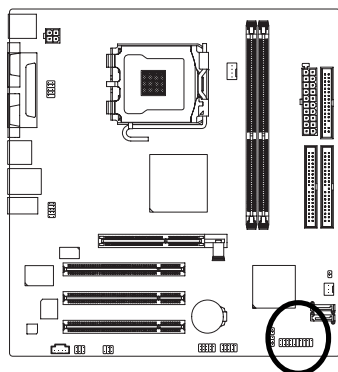

HD (IDE Hard Disk Active LED)	Pin 1: LED anode(+) Pin 2: LED cathode(-)
SPEAK (Speaker Connector)	Pin 1: VCC(+) Pin 2- Pin 3: NC Pin 4: Data(-)
RES (Reset Switch)	Open: Normal Operation Close: Reset Hardware System
PW (Power Switch)	Open: Normal Operation Close: Power On/Off
MSG (Message LED/Power/Sleep LED)	Pin 1: LED anode(+) Pin 2: LED cathode(-)
NC	NC

### 11) CD\_IN (CD IN Connector)

Connect CD-ROM or DVD-ROM audio out to the connector.

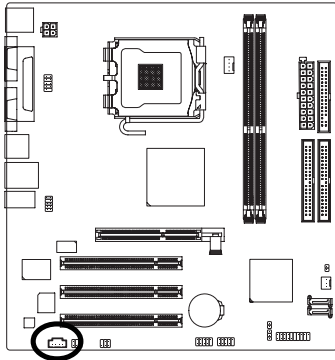

Pin No.	Definition
1	CD-L
2	GND
3	GND
4	CD-R

### 12) SPDIF\_IO (SPDIF In/ Out)

The SPDIF output is capable of providing digital audio to external speakers or compressed AC3 data to an external Dolby Digital Decoder. Use this feature only when your stereo system has digital input function. Use SPDIF IN feature only when your device has digital output function. Be careful with the polarity of the SPDIF\_IO connector. Check the pin assignment carefully while you connect the SPDIF\_IO cable. Incorrect connection between the cable and connector will make the device unable to work or even damage it. For optional SPDIF\_IO cable, please contact your local dealer.

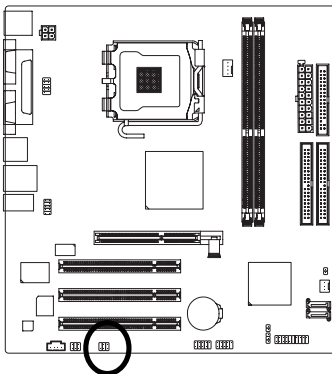

Pin No.	Definition
1	VCC
2	No Pin
3	SPDIF
4	SPDIFI
5	GND
6	GND

### 13) F1\_USB / F2\_USB (Front USB Connectors)

Be careful with the polarity of the front USB connector. Check the pin assignment carefully while you connect the front USB cable, incorrect connection between the cable and connector will make the device unable to work or even damage it. For optional front USB cable, please contact your local dealer.

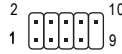
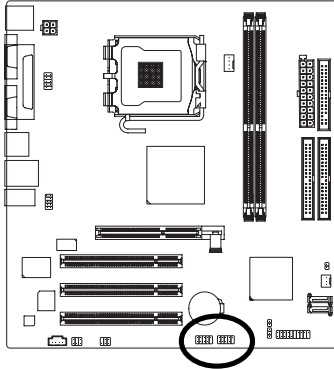

Pin No.	Definition
1	Power
2	Power
3	USB0 DX-
4	USB1 Dy-
5	USB0 DX+
6	USB1 Dy+
7	GND
8	GND
9	No Pin
10	NC

### 14) CI (Chassis Intrusion, Case Open)

This 2-pin connector allows your system to detect if the chassis cover is removed. You can check the "Case Open" status in BIOS Setup.

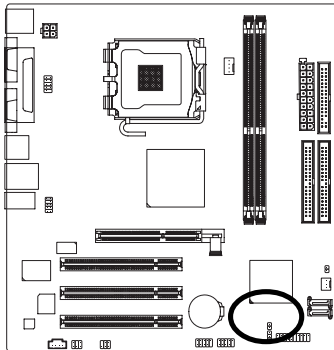

Pin No.	Definition
1	Signal
2	GND



### 15) CLR\_CMOS (Clear CMOS)

You may clear the CMOS data to its default values by this jumper. To clear CMOS, temporarily short pins 1-2. To prevent improper use of this header, we do not include a jumper on it.

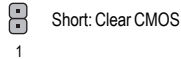
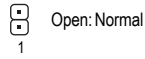
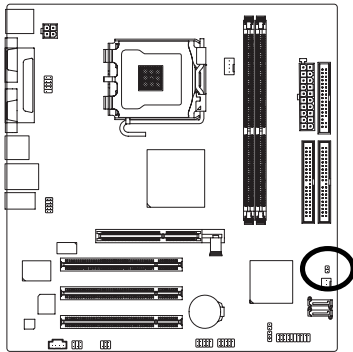

### 16) COMB (COMB Connector)

Be careful with the polarity of the COMB connector. Check the pin assignments while you connect the COMB cable. Please contact your nearest dealer for optional COMB cable.

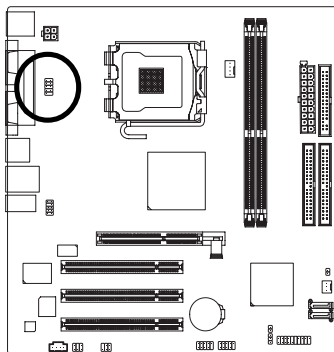

Pin No.	Definition
1	NDCDA-
2	NSINA
3	NSOUTA
4	NDTRA-
5	GND
6	NDSRA-
7	NRTSA-
8	NCTSA-
9	NRIA-
10	No Pin

## 17) PWR\_LED

PWR\_LED is connected with the system power indicator to indicate whether the system is on/off. It will blink when the system enters suspend mode.

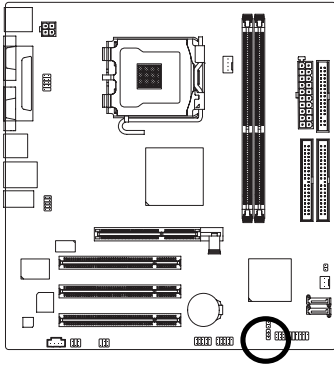

1

Pin No.	Definition
1	MPD+
2	MPD-
3	MPD-

## 18) BAT (Battery)

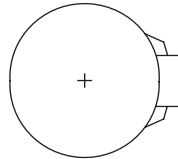
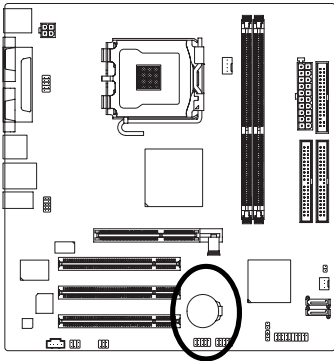

- ❖ Danger of explosion if battery is incorrectly replaced.
- ❖ Replace only with the same or equivalent type recommended by the manufacturer.
- ❖ Dispose of used batteries according to the manufacturer's instructions.

If you want to erase CMOS...

1. Turn OFF the computer and unplug the power cord.
2. Take out the battery gently and put it aside for about 10 minutes. (Or you can use a metal object to connect the positive and negative pins in the battery holder to makethem short for one minute.)
3. Re-install the battery.
4. Plug the power cord and turn ON the computer.





## Chapter 2 BIOS Setup

BIOS (Basic Input and Output System) includes a CMOS SETUP utility which allows user to configure required settings or to activate certain system features.

The CMOS SETUP saves the configuration in the CMOS SRAM of the motherboard.

When the power is turned off, the battery on the motherboard supplies the necessary power to the CMOS SRAM.

When the power is turned on, pushing the <Del> button during the BIOS POST (Power-On Self Test) will take you to the CMOS SETUP screen. You can enter the BIOS setup screen by pressing "Ctrl + F1".

When setting up BIOS for the first time, it is recommended that you save the current BIOS to a disk in the event that BIOS needs to be reset to its original settings. If you wish to upgrade to a new BIOS, either Gigabyte's Q-Flash or @BIOS utility can be used.

Q-Flash allows the user to quickly and easily update or backup BIOS without entering the operating system. @BIOS is a Windows-based utility that does not require users to boot to DOS before upgrading BIOS but directly download and update BIOS from the Internet.

### CONTROL KEYS

< ↑ > < ↓ > < ← > < → >	Move to select item
<Enter>	Select Item
<Esc>	Main Menu - Quit and not save changes into CMOS Status Page Setup Menu and Option Page Setup Menu - Exit current page and return to Main Menu
<Page Up>	Increase the numeric value or make changes
<Page Down>	Decrease the numeric value or make changes
<F1>	General help, only for Status Page Setup Menu and Option Page Setup Menu
<F2>	Item Help
<F5>	Restore the previous CMOS value from CMOS, only for Option Page Setup Menu
<F6>	Load the fail-safe default CMOS value from BIOS default table
<F7>	Load the Optimized Defaults
<F8>	Q-Flash utility
<F9>	System Information
<F10>	Save all the CMOS changes, only for Main Menu

### Main Menu

The on-line description of the highlighted setup function is displayed at the bottom of the screen.

### Status Page Setup Menu / Option Page Setup Menu

Press F1 to pop up a small help window that describes the appropriate keys to use and the possible selections for the highlighted item. To exit the Help Window press <Esc>.

## The Main Menu (For example: BIOS Ver. : E3)

Once you enter Award BIOS CMOS Setup Utility, the Main Menu (as figure below) will appear on the screen. Use arrow keys to select among the items and press <Enter> to accept or enter the sub-menu.

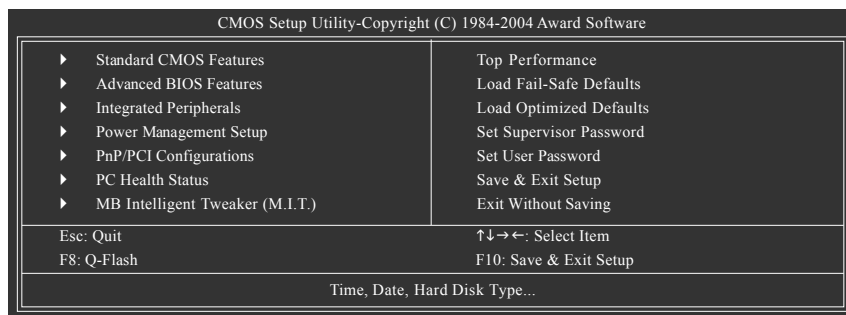

If you can't find the setting you want, please press "Ctrl+F1" to access hidden advanced options.

### ■ Standard CMOS Features

This setup page includes all the items in standard compatible BIOS.

### ■ Advanced BIOS Features

This setup page includes all the items of Award special enhanced features.

### ■ Integrated Peripherals

This setup page includes all onboard peripherals.

### ■ Power Management Setup

This setup page includes all the items of Green function features.

### ■ PnP/PCI Configuration

This setup page includes all the configurations of PCI & PnP ISA resources.

### ■ PC Health Status

This setup page includes information about the CPU autodetected temperature, voltage, and fan, speed.

### ■ MB Intelligent Tweaker (M.I.T.)

This setup page is to control CPU clock and frequency.

### ■ Top Performance

If you wish to maximize the performance of your system, try to enable **Top Performance**.

### ■ Load Fail-Safe Defaults

Fail-Safe Defaults refers to the value of the system parameters with which the system would be in safe configuration.

### ■ Load Optimized Defaults

Optimized Defaults refers to the value of the system parameters with which the system would be in best performance configuration.

- **Set Supervisor Password**

Change, set, or disable password. It allows you to limit access to the system and Setup, or just to Setup.

- **Set User Password**

Change, set, or disable password. It allows you to limit access to the system.

- **Save & Exit Setup**

Save CMOS value settings to CMOS and exit setup.

- **Exit Without Saving**

Abandon all CMOS value changes and exit setup.

## 2-1 Standard CMOS Features

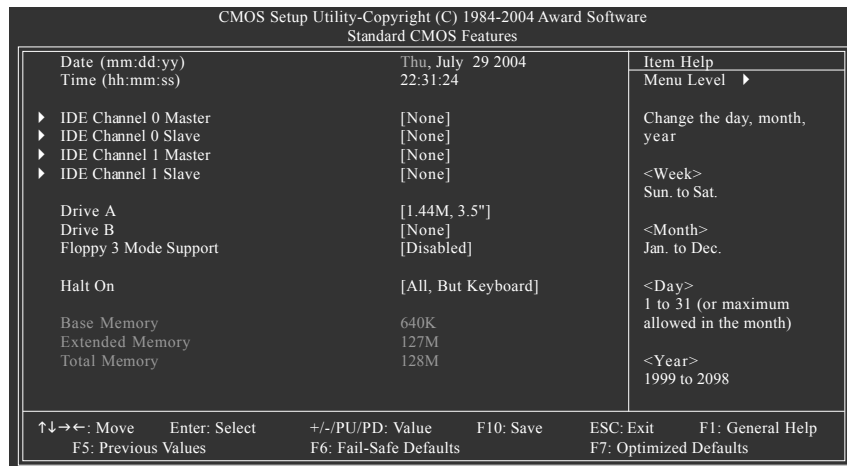

### ☞ Date

The date format is <week>, <month>, <day>, <year>.

- ▶▶ Week            The weekday, from Sun. to Sat., is determined by the BIOS and displayed only.
- ▶▶ Month            The month, from Jan. to Dec.
- ▶▶ Day                The date, from 1 to 31 (or the maximum allowed in the month).
- ▶▶ Year                The year, from 1999 through 2098.

### ☞ Time

The times format in <hour> <minute> <second>. The time is calculated based on the 24-hour military-time clock. For example, 1 p.m. is 13:00:00.

### ☞ IDE Channel 0 Master, Slave /IDE Channel 1 Master, Slave

- ▶▶ IDE HDD Auto-Detection    Press "Enter" to select this option for automatic device detection.
- ▶▶ IDE Channel 0/Channel 1 Master(Slave) setup    You can use one of the three methods below:
  - Auto            Allows BIOS to automatically detect IDE devices during POST. (Default value)
  - None            Select this if no IDE devices are used and the system will skip the automatic detection step and allow for faster system start up.
  - Manual            User can manually input the correct settings
- ▶▶ Access Mode    Use this to set the access mode for the hard drive. The four options are: CHS/LBA/Large/Auto (Default:Auto)
- ▶▶ Capacity        Capacity of currently installed hard disk.  
Hard drive information should be labeled on the outside drive casing.  
Enter the appropriate option based on this information.
- ▶▶ Cylinder        Number of cylinders
- ▶▶ Head             Number of heads
- ▶▶ Precomp         Write precomp
- ▶▶ Landing Zone    Landing zone
- ▶▶ Sector            Number of sectors



### ☞ Drive A / Drive B

The category identifies the types of floppy disk drive A or drive B that has been installed in the computer.

- ▶▶ None                      No floppy drive installed
- ▶▶ 360K, 5.25"              5.25 inch PC-type standard drive; 360K byte capacity.
- ▶▶ 1.2M, 5.25"              5.25 inch AT-type high-density drive; 1.2M byte capacity  
(3.5 inch when 3 Mode is Enabled).
- ▶▶ 720K, 3.5"                3.5 inch double-sided drive; 720K byte capacity
- ▶▶ 1.44M, 3.5"              3.5 inch double-sided drive; 1.44M byte capacity. (Default value)
- ▶▶ 2.88M, 3.5"              3.5 inch double-sided drive; 2.88M byte capacity.

### ☞ Floppy 3 Mode Support (for Japan Area)

- ▶▶ Disabled                 Normal Floppy Drive. (Default value)
- ▶▶ Drive A                  Drive A is 3 mode Floppy Drive.
- ▶▶ Drive B                  Drive B is 3 mode Floppy Drive.
- ▶▶ Both                      Drive A & B are 3 mode Floppy Drives.

### ☞ Halt on

The category determines whether the computer will stop if an error is detected during power-up.

- ▶▶ No Errors                 The system boot will not stop for any error that may be detected and you will be prompted.
- ▶▶ All Errors                Whenever the BIOS detects a non-fatal error the system will be stopped.
- ▶▶ All, But Keyboard        The system boot will not stop for a keyboard error; it will stop for all other errors. (Default value)
- ▶▶ All, But Diskette        The system boot will not stop for a disk error; it will stop for all other errors.
- ▶▶ All, But Disk/Key        The system boot will not stop for a keyboard or disk error; it will stop for all other errors.

### ☞ Memory

The category is display-only and is determined by POST (Power On Self Test) of the BIOS.

#### ▶▶ Base Memory

The POST of the BIOS will determine the amount of base (or conventional) memory installed in the system.

The value of the base memory is typically 512K for systems with 512K memory installed on the motherboard, or 640K for systems with 640K or more memory installed on the motherboard.

#### ▶▶ Extended Memory

The BIOS determines how much extended memory is present during the POST.

This is the amount of memory located above 1 MB in the CPU's memory address map.

#### ▶▶ Total Memory

This item displays the memory size that used.

## 2-2 Advanced BIOS Features

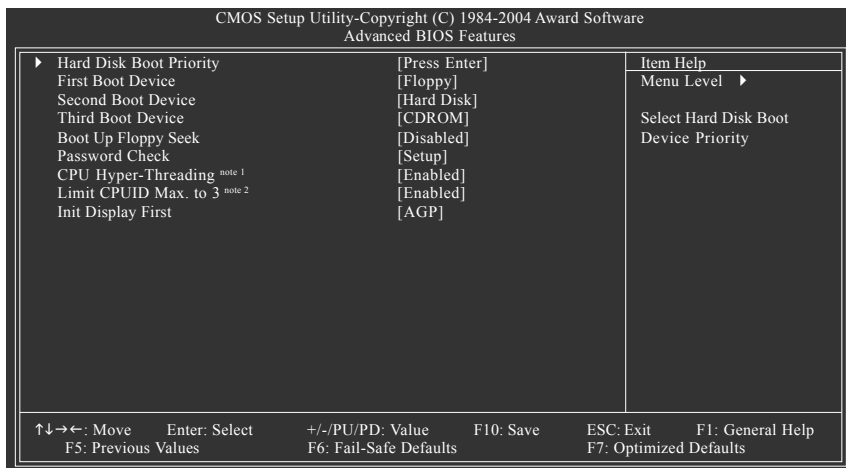

Note 1: This option is available only when the processor you install supports Intel® Hyper-Threading Technology.

Note 2: This option is available only when you install an Intel® Prescott processor.

### ☞ Hard Disk Boot Priority

Select boot sequence for onboard (or add-on cards) SCSI, RAID, etc.

Use <↑> or <↓> to select a device, then press<+> to move it up, or <-> to move it down the list. Press <ESC> to exit this menu.

### ☞ First / Second / Third Boot Device

- ▶ Floppy            Select your boot device priority by Floppy.
- ▶ LS120            Select your boot device priority by LS120.
- ▶ Hard Disk        Select your boot device priority by Hard Disk.
- ▶ CDROM            Select your boot device priority by CDROM.
- ▶ ZIP                Select your boot device priority by ZIP.
- ▶ USB-FDD         Select your boot device priority by USB-FDD.
- ▶ USB-ZIP          Select your boot device priority by USB-ZIP.
- ▶ USB-CDROM      Select your boot device priority by USB-CDROM.
- ▶ USB-HDD         Select your boot device priority by USB-HDD.
- ▶ LAN                Select your boot device priority by LAN.
- ▶ Disabled         Select your boot device priority by Disabled.

### ☞ **Boot Up Floppy Seek**

During POST, BIOS will determine if the installed floppy disk drive is 40 or 80 tracks. 360K type is 40 tracks 720K, 1.2M and 1.44M are all 80 tracks.

- ▶▶ Disabled BIOS will not search for the type of floppy disk drive by track number. Note that there will not be any warning message if the drive installed is 360K. (Default value)
- ▶▶ Enabled BIOS searches for floppy disk drive to determine if it is 40 or 80 tracks. Note that BIOS can not tell from 720K, 1.2M or 1.44M drive type as they are all 80 tracks.

### ☞ **Password Check**

- ▶▶ Setup The system will boot but will not access to Setup page if the correct password is not entered at the prompt. (Default value)
- ▶▶ System The system will not boot and will not access to Setup page if the correct password is not entered at the prompt.

If you want to cancel the setting of password, please just press ENTER to make [SETUP] empty.

### ☞ **CPU Hyper-Threading**

This option appears only when the processor you install supports Intel® Hyper-Threading Technology.

- ▶▶ Enabled Enable CPU Hyper-Threading feature. Please note that this feature only works for operating system with multiprocessors mode supported. (Default value)
- ▶▶ Disabled Disable CPU Hyper-Threading.

### ☞ **Limit CPUID Max. to 3**

This option is available only when you install an Intel® Prescott processor

- ▶▶ Enabled Limit CPUID Maximum value to 3 when using older OS like NT4. (Defaults value)
- ▶▶ Disabled Disable CPUID Limit for Windows XP.

### ☞ **Init Display First**

Select the first initiation of the monitor display from AGP or PCI VGA card.

- ▶▶ PCI Set Init Display First to PCI VGA card.
- ▶▶ AGP Set Init Display First to AGP VGA card.(Default value)

## 2-3 Integrated Peripherals

CMOS Setup Utility-Copyright (C) 1984-2004 Award Software Integrated Peripherals		
IDE1 Conductor Cable	[Auto]	Item Help
IDE2 Conductor Cable	[Auto]	Menu Level ▶
On-Chip Primary PCI IDE	[Enabled]	
On-Chip Secondary PCI IDE	[Enabled]	[Auto]
AC97 Audio	[Enabled]	Auto-detect IDE cable type
Onboard LAN device	[Enabled]	
USB Controller	[Enabled]	
USB Legacy Support	[Disabled]	
SiS Serial ATA Controller	[Enabled]	[ATA 66/100/133]
SiS Serial ATA Mode	[RAID]	Set Conductor Cable to ATA66/100/133 (80 Pins)
Onboard Serial Port 1	[3F8/IRQ4]	
Onboard Serial Port 2	[2F8/IRQ3]	
Onboard Parallel Port	[378/IRQ7]	
Parallel Port Mode	[ECP]	[Disabled]
ECP Mode Use DMA	3	Set Conductor Cable ATA33 (40 Pins)

↑↓→←: Move	Enter: Select	+/-/PU/PD: Value	F10: Save	ESC: Exit	F1: General Help
F5: Previous Values		F6: Fail-Safe Defaults		F7: Optimized Defaults	

### ☞ IDE1 Conductor Cable

- ▶▶ Auto BIOS autodetects IDE1 conductor cable. (Default Value)
- ▶▶ ATA66/100/133 Set IDE1 Conductor Cable to ATA66/100/133. (Please make sure your IDE device and cable are compatible with ATA66/100/133).
- ▶▶ ATA33 Set IDE1 Conductor Cable to ATA33. (Please make sure your IDE device and cable are compatible with ATA33)

### ☞ IDE2 Conductor Cable

- ▶▶ Auto BIOS autodetects IDE2 conductor cable. (Default Value)
- ▶▶ ATA66/100/133 Set IDE2 Conductor Cable to ATA66/100/133. (Please make sure your IDE device and cable are compatible with ATA66/100/133)
- ▶▶ ATA33 Set IDE2 Conductor Cable to ATA33. (Please make sure your IDE device and cable are compatible with ATA33)

### ☞ On-Chip Primary PCI IDE

- ▶▶ Enabled Enable onboard 1st channel IDE port. (Default value)
- ▶▶ Disabled Disable onboard 1st channel IDE port.

### ☞ On-Chip Secondary PCI IDE

- ▶▶ Enabled Enable onboard 2nd channel IDE port. (Default value)
- ▶▶ Disabled Disable onboard 2nd channel IDE port.

### ☞ AC97 Audio

- ▶▶ Enabled Autodetect AC97 audio function. (Default value)
- ▶▶ Disabled Disable AC97 audio function.

### ☞ Onboard LAN device

- ▶▶ Enabled Enable Onboard LAN device function. (Default value)
- ▶▶ Disabled Disable this function.

### ☞ USB Controller

- ▶▶ Enabled Enable USB Controller. (Default value)
- ▶▶ Disabled Disable USB Controller.

### ☞ USB Legacy Support

- ▶▶ Enabled Enable USB Legacy Support.
- ▶▶ Disabled Disable USB Legacy Support. (Default value)

### ☞ SiS Serial ATA Controller

- ▶▶ Enabled Enable SiS Serial ATA Controller.(Default value)
- ▶▶ Disabled Disable SiS Serial ATA Controller.

### ☞ SiS Serial ATA Mode

- ▶▶ IDE Set SiS Serial ATA Mode to IDE.
- ▶▶ RAID Set SiS Serial ATA Mode to RAID (Default value).

### ☞ Onboard Serial Port 1

- ▶▶ Auto BIOS will automatically setup the Serial port 1 address.
- ▶▶ 3F8/IRQ4 Enable onboard Serial port 1 and address is 3F8/IRQ4. (Default value)
- ▶▶ 2F8/IRQ3 Enable onboard Serial port 1 and address is 2F8/IRQ3.
- ▶▶ 3E8/IRQ4 Enable onboard Serial port 1 and address is 3E8/IRQ4.
- ▶▶ 2E8/IRQ3 Enable onboard Serial port 1 and address is 2E8/IRQ3.
- ▶▶ Disabled Disable onboard Serial port 1.

### ☞ Onboard Serial Port 2

- ▶▶ Auto BIOS will automatically set up the Serial port 2 address.
- ▶▶ 3F8/IRQ4 Enable onboard Serial port 2 and address is 3F8/IRQ4.
- ▶▶ 2F8/IRQ3 Enable onboard Serial port 2 and address is 2F8/IRQ3. (Default value)
- ▶▶ 3E8/IRQ4 Enable onboard Serial port 2 and address is 3E8/IRQ4.
- ▶▶ 2E8/IRQ3 Enable onboard Serial port 2 and address is 2E8/IRQ3.
- ▶▶ Disabled Disable onboard Serial port 2.

### ☞ Onboard Parallel Port

- ▶▶ Disabled Disable onboard LPT port.
- ▶▶ 378/IRQ7 Enable onboard LPT port and address is 378/IRQ7. (Default value)
- ▶▶ 278/IRQ5 Enable onboard LPT port and address is 278/IRQ5.
- ▶▶ 3BC/IRQ7 Enable onboard LPT port and address is 3BC/IRQ7.

### ☞ Parallel Port Mode

- ▶▶ SPP Use Parallel port as Standard Parallel Port.
- ▶▶ EPP Use Parallel port as Enhanced Parallel Port.
- ▶▶ ECP Use Parallel port as Extended Capabilities Port. (Default value)
- ▶▶ ECP+EPP Use Parallel port as ECP & EPP mode.

### ☞ ECP Mode Use DMA

This option is available only when **Parallel Port Mode** is set to ECP or ECP+EPP.

- ▶▶ 3 Set ECP Mode Use DMA to 3. (Default value)
- ▶▶ 1 Set ECP Mode Use DMA to 1.



### ☞ **PME Event Wake Up**

This feature requires an ATX power supply that provides at least 1A on the 5VSB lead.

- ▶▶ Disabled      Disable this function.
- ▶▶ Enabled      Enable PME Event Wake up. (Default value)

### ☞ **Power On By Keyboard**

- ▶▶ Password      Enter one to five characters to set the Keyboard Power On password.
- ▶▶ Disabled      Disabled this function. (Default value)
- ▶▶ Any Key      Press any key to turn on the computer.

### ☞ **Power On By Mouse**

- ▶▶ Disabled      Disable this function. (Default value)
- ▶▶ Enabled      Move or click the left button of the PS/2 mouse to turn on the computer.

### ☞ **Resume by Alarm**

You can enable **Resume by Alarm** and set date/time to turn on your system.

- ▶▶ Disabled      Disable this function. (Default value)
- ▶▶ Enabled      Enable **Resume by Alarm** function to turn on system.

If **Resume by Alarm** is Enabled:

- ▶▶ Month Alarm:    Jan.~Dec.
- ▶▶ Day (of Month):    Everyday, 1~31
- ▶▶ Time (hh: mm: ss): (0~23) : (0~59) : (0~59)

### ☞ **Power LED in S1 State**

- ▶▶ Blinking      The Power LED will be blinking during S1 state. (Default value)
- ▶▶ Dual/OFF      The Power LED will be turned off or change color.

## 2-5 PnP/PCI Configurations

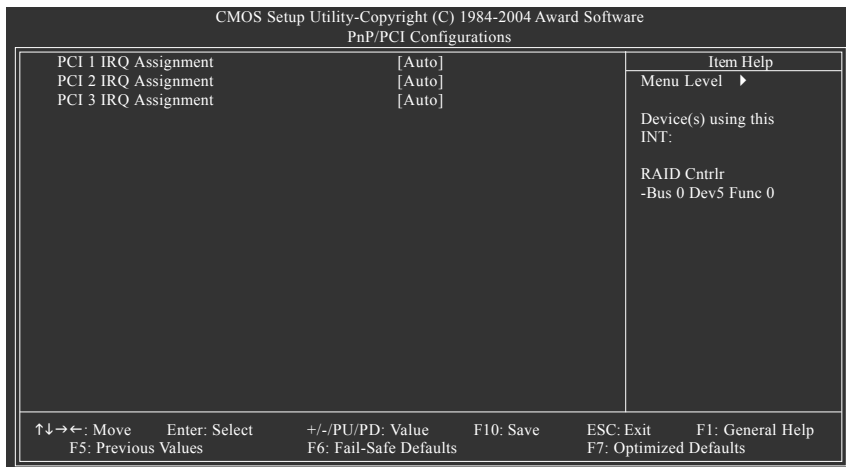

### PCI 1 IRQ Assignment

- ▶▶ Auto                      Auto assign IRQ to PCI 1. (Default value)
- ▶▶ 3,4,5,7,9,10,11,12,14,15    Set IRQ 3,4,5,7,9,10,11,12,14,15 to PCI 1.

### PCI 2 IRQ Assignment

- ▶▶ Auto                      Auto assign IRQ to PCI 2. (Default value)
- ▶▶ 3,4,5,7,9,10,11,12,14,15    Set IRQ 3,4,5,7,9,10,11,12,14,15 to PCI 2.

### PCI 3 IRQ Assignment

- ▶▶ Auto                      Auto assign IRQ to PCI 3. (Default value)
- ▶▶ 3,4,5,7,9,10,11,12,14,15    Set IRQ 3,4,5,7,9,10,11,12,14,15 to PCI 3.



## 2-6 PC Health Status

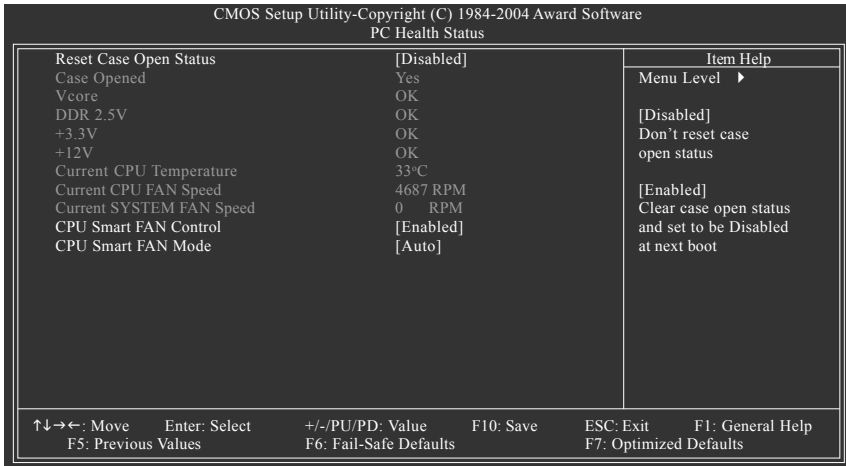

### ☞ Reset Case Open Status

- ▶▶ Disabled      Don't reset case open status. (Default value)
- ▶▶ Enabled      Clear case open status at next boot.

### ☞ Case Opened

If the case is closed, **Case Opened** will show "No."

If the case is opened, **Case Opened** will show "Yes."

If you want to reset **Case Opened** value, enable **Reset Case Open Status** and save the change to CMOS, and then your computer will restart.

### ☞ Current Voltage(V) Vcore / DDR 2.5V / +3.3V / +12V

- ▶▶ Detect system's voltage status automatically.

### ☞ Current CPU Temperature

- ▶▶ Detect CPU temperature automatically.

### ☞ Current CPU/SYSTEM FAN Speed (RPM)

- ▶▶ Detect CPU/SYSTEM fan speed status automatically.

### ☞ CPU Smart FAN Control

- ▶▶ Eabled      Enable the **CPU Smart FAN Control** function. (Default Value)
  - a. When the CPU temperature is higher than 65 degrees Celsius, CPU fan will operate at full speed.
  - b. When the CPU temperature is between 20 and 65 degrees Celsius, the CPU fan speed will change depending on the actual CPU temperature.
  - c. When the CPU temperature is lower than 20 degrees Celsius, CPU fan will stop spinning.
- ▶▶ Disabled      Disable the **CPU Smart FAN Control** function.

## ☞ CPU Smart FAN Mode

This option is available only when **CPU Smart FAN Control** is enabled.

- ▶▶ Auto BIOS autodetects the type of CPU fan you installed and sets the optimal CPU Smart FAN control mode for it. (Default Value)
- ▶▶ Voltage Set to Voltage when you use a CPU fan with a 3-pin fan power cable.
- ▶▶ PWM Set to PWM when you use a CPU fan with a 4-pin fan power cable.



NOTE

In fact, the Voltage option can be used for CPU fans with 3-pin or 4-pin power cables. However, some 4-pin CPU fan power cables are not designed following Intel 4-wire fans PWM control specifications. With such CPU fans, selecting PWM will not effectively reduce the fan speed.

## 2-7 MB Intelligent Tweaker (M.I.T.)

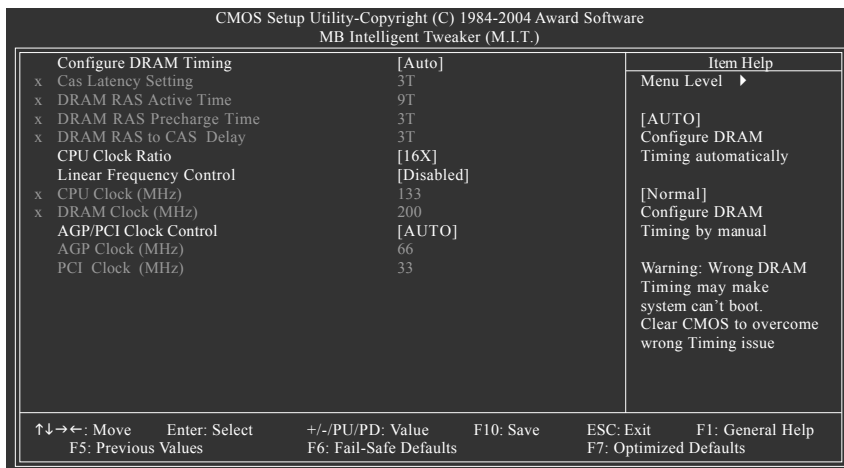

CAUTION

Incorrect using these features may cause your system corrupted. For power users only.

### ☞ Configure DRAM Timing

- ▶▶ Auto BIOS will automatically set up the DRAM Timing by DRAM SPD data. (Default value)
- ▶▶ Manual This item allows user to set DRAM Timing manually.

### ☞ CAS Latency Setting

- ▶▶ 2T/2.5T/3T Set CAS Latency to 2T/2.5T/3T (Default value is 3T).
- ▶▶ Auto BIOS will automatically detect CAS Latency.

☞ **DRAM RAS Active Time**

▶▶ 4T/5T/6T/7T/8T/9T Set DRAM RAS Active Time to 4T/5T/6T/7T/8T/9T. (Default value:9T)

☞ **DRAM RAS Precharge Time**

▶▶ 3T/2T/4T/5T Set DRAM RAS Precharge time to 2T/3T/4T/5T. (Default value:3T)

☞ **DRAM RAS to CAS Delay**

▶▶ 3T/2T/4T/5T Set DRAM RAS to CAS Delay to 3T/2T/4T/5T. (Default value:3T)

☞ **CPU Clock Ratio (MHz)**

This setup option will be automatically assigned by CPU detection.

The option will display "Locked" and read only if the CPU ratio is not changeable.

☞ **Linear Frequency Control**

▶▶ Disabled Disable this function. (Default value)

▶▶ Enabled Enable this function.

☞ **CPU Clock (MHz)**

This option is available only when **Linear Frequency Control** is enabled.

▶▶ 100~355 Select CPU Clock to 100MHz~355MHz.

If you use a Pentium 4 processor with 800MHz FSB, please set "CPU Clock" to 200MHz.

Incorrect using it may cause your system corrupted. For power users only!

☞ **DRAM Clock (MHz)**

This option is available only when **Linear Frequency Control** is enabled.

Please set DRAM Clock according to your requirement.

If you use DDR266 DRAM module, please set "DRAM Clock(MHz)" to 266. If you use DDR333

DRAM module, please set "DRAM Clock(MHz)" to 333.

Incorrect using it may cause your system corrupted. For power users only!

☞ **AGP/PCI Clock Control**

▶▶ AUTO Set AGP/PCI clock automatically. (Default Value)

▶▶ Manual Set AGP/PCI clock manually.

Incorrect using it may cause your system corrupted. For power users only!

☞ **AGP Clock (MHz)**

This option is available only when **AGP/PCI Clock Control** is set to Manual.

▶▶ Please set AGP Clock according to your requirement.

Incorrect using it may cause your system corrupted. For power users only!

☞ **PCI Clock (MHz)**

When you select to set the AGP Clock (MHz) manually, the PCI Clock (MHz) will change automatically depending on the AGP Clock (MHz) you set.

## 2-8 Top Performance

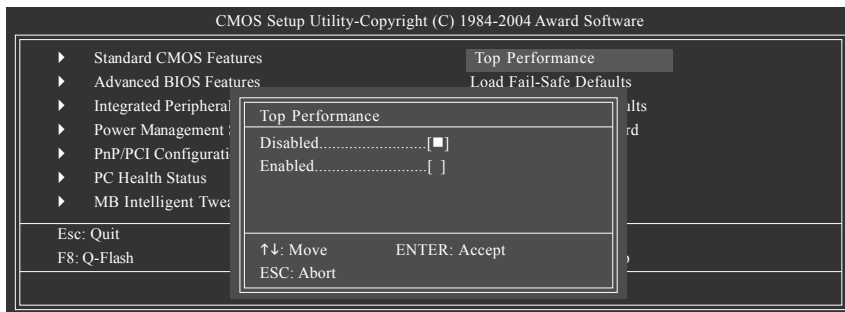

If you wish to maximize the performance of your system, enable "Top Performance."

- ▶▶ Disabled Disable this function. (Default Value)
- ▶▶ Enabled Enable Top Performance function.

☛\* "Top Performance" will increase H/W working speed. Different system configuration (both H/W component and OS) will affect the result. For example, the same H/W configuration might not run properly with Windows XP, but works smoothly with Windows NT. Therefore, if your system is not perform enough, the reliability or stability problem will appear sometimes, and we will recommend you disabling the option to avoid the problem as mentioned above.

## 2-9 Load Fail-Safe Defaults

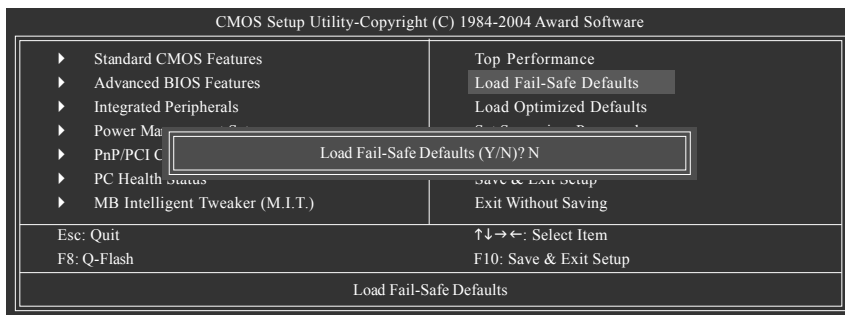

Fail-Safe defaults contain the most appropriate values of the system parameters that allow minimum system performance.

## 2-10 Load Optimized Defaults

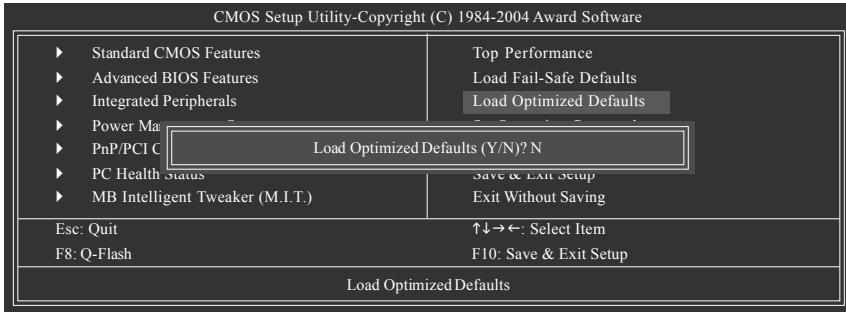

Selecting this field loads the factory defaults for BIOS and Chipset Features which the system automatically detects.

## 2-11 Set Supervisor/User Password

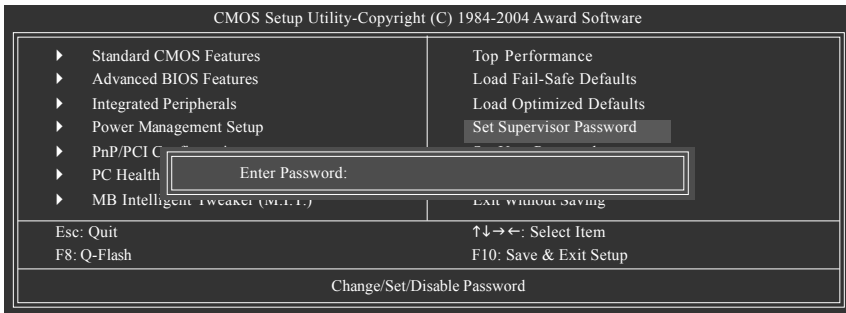

Selecting this field loads the factory defaults for BIOS and Chipset Features which the system automatically detects.

When you select this function, the following message will appear at the center of the screen to assist you in creating a password.

Type the password, up to eight characters, and press <Enter>. You will be asked to confirm the password. Type the password again and press <Enter>. You may also press <Esc> to abort the selection and not enter a password.

To disable password, just press <Enter> when you are prompted to enter password. A message "PASSWORD DISABLED" will appear to confirm the password being disabled. Once the password is disabled, the system will boot and you can enter Setup freely.

The BIOS Setup program allows you to specify two separate passwords:

SUPERVISOR PASSWORD and a USER PASSWORD. When disabled, anyone may access all BIOS Setup program function. When enabled, the Supervisor password is required for entering the BIOS Setup program and having full configuration fields, the User password is required to access only basic items.

If you select "System" at "Password Check" in Advance BIOS Features Menu, you will be prompted for the password every time the system is rebooted or any time you try to enter Setup Menu.

If you select "Setup" at "Password Check" in Advance BIOS Features Menu, you will be prompted only when you try to enter Setup.

## 2-12 Save & Exit Setup

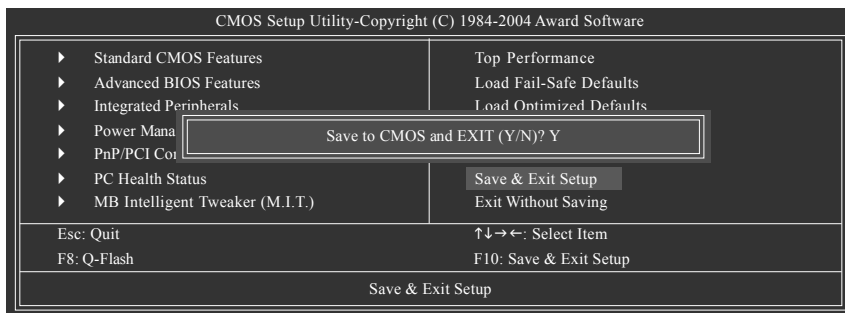

Type "Y" will quit the Setup Utility and save the user setup value to RTC CMOS.

Type "N" will return to Setup Utility.

## 2-13 Exit Without Saving

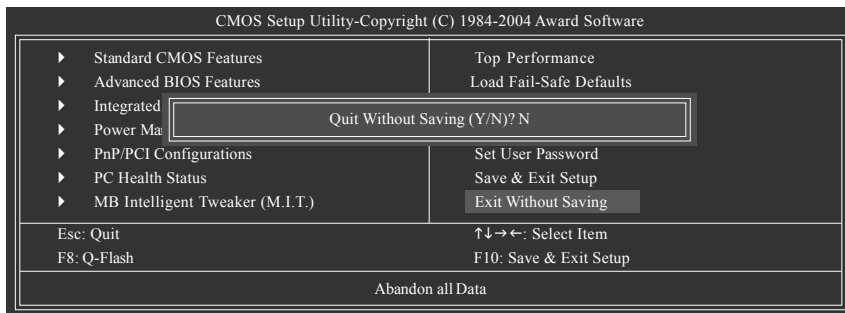

Type "Y" will quit the Setup Utility without saving to RTC CMOS.

Type "N" will return to Setup Utility.







# Chapter 3 Drivers Installation



Pictures below are shown in Windows XP.

- (1) Please make sure to install the latest service pack for Windows after OS installation and before installing motherboard drivers.
- (2) Insert the driver CD that came with your motherboard into your CD-ROM drive, the driver CD will auto start and installation screen will appear. If not, please double click the CD-ROM device icon in **My computer** or execute the Setup.exe in the root directory of the driver CD.

## 3-1 Install Chipset Drivers

This page shows the drivers that need to be installed for the system. Click each item to install the driver manually or click the Xpress Install button  to install the drivers automatically.

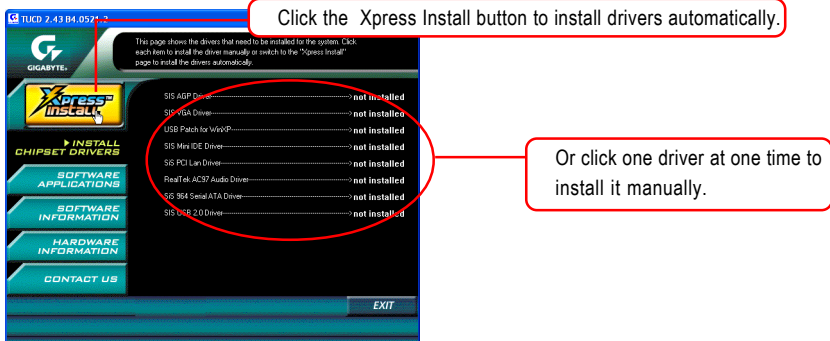

The Xpress Install uses the "Click and Go" technology to install the drivers automatically. Just select the drivers you want then click the "GO" button. The Xpress Install will execute the installation for you by itself.

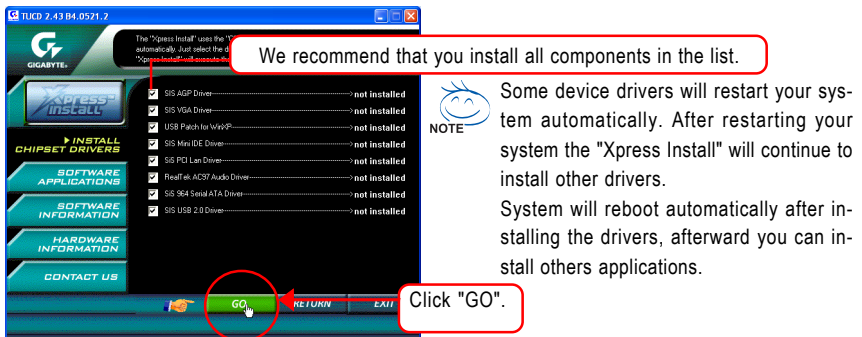

For USB2.0 driver support under Windows XP operating system, please use Windows Service Pack. After install Windows Service Pack, it will show a question mark "?" in "Universal Serial Bus controller" under "Device Manager". Please remove the question mark and restart the system (System will auto-detect the right USB2.0 driver).

## 3-2 Software Applications

This page displays all the tools that Gigabyte developed and some free software, you can choose anyone you want and press "install" to install them.

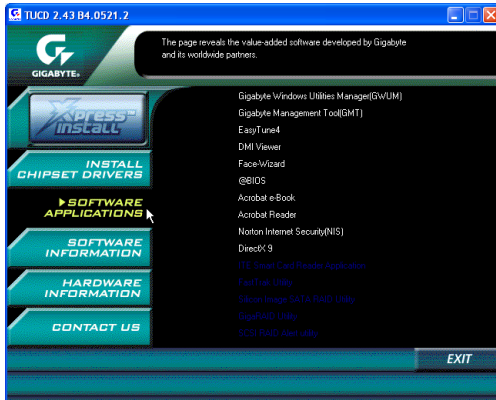

## 3-3 Driver CD Information

This page lists the contents of software and drivers in this CD-title.

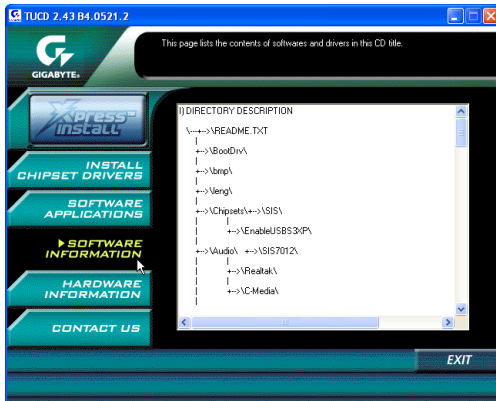

### 3-4 Hardware Information

This page lists all device you have for this motherboard.



### 3-5 Contact Us

You can also see the last page of this manual for contacts information details.





## Chapter 4 Appendix

### 4-1 Unique Software Utility

(Not all models support these unique software utilities, please check your motherboard features.)

#### 4-1-1 Xpress Recovery2 Introduction



Xpress Recovery2 is designed to provide quick backup and restoration of hard disk data. Supporting Microsoft operating systems including Windows XP/2000/NT/98/Me and DOS, and file systems including FAT16, FAT32, and NTFS, Xpress Recovery2 is able to back up data on hard disks on PATA and SATA IDE controllers. After Xpress Recovery2 is executed from CD-ROM for the first time, it will stay permanent in your hard disk. If you wish to run Xpress Recovery2 later, you can simply press F9 during system bootup to enter Xpress Recovery2 without the CD-ROM.

#### System requirements:

1. Intel x86 platforms
2. At least 64M bytes of system memory
3. VESA-supported VGA cards

#### How to use the Xpress Recovery2

Initial access by booting from CD-ROM and subsequent access by pressing the F9 key:

Steps: After entering BIOS Setup, go to **Advanced BIOS Feature** and set to boot from CD-ROM. Save the settings and exit the BIOS Setup. Insert the provided driver CD into your CD-ROM drive. Upon system restart, the message which says "Boot from CD/DVD:" will appear in the bottom left corner of the screen. Press any key to enter Xpress Recovery2.

After the steps above are completed, subsequent access to Xpress Recovery2 can be made by simply pressing the <F9> key during system power-on.



Boot from CD/DVD:

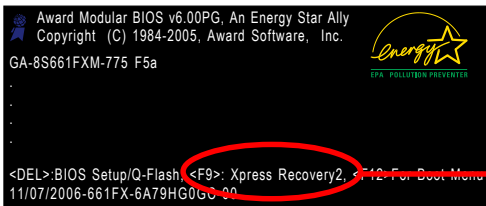

<F9> Xpress Recovery2



NOTE

1. If you have already entered Xpress Recovery2 by booting from the CD-ROM, you can enter Xpress Recovery2 by pressing the <F9> key in the future.
2. System storage capacity and the reading/writing speed of the hard disk will affect the data backup speed.
3. It is recommended that Xpress Recovery2 be immediately installed once you complete installations of OS and all required drivers as well as software.

## The Main Screen of Xpress Recovery2



### 1. RESTORE:

Restore the backed-up data to your hard disk.  
(This button will not appear if there is no backup file.)

### 2. BACKUP:

Back up data from hard disk.

### 3. REMOVE:

Remove previously-created backup files to release disk space.  
(This button will not appear if there is no backup file.)

### 4. REBOOT:

Exit the main screen and restart the system.

### Limitations:

1. Not compatible to Xpress Recovery.
2. For the use of Xpress Recovery2, a primary partition must be reserved.
3. Xpress Recovery2 will store the backup file at the end of the hard disk, so free space available on the hard disk for the backup file must be allocated in advance. (A minimum 4GB is recommended but the actual space is dependent on the size of the data to be backed up)
4. Capable of backing up hard disks installed with Windows operating systems including DOS and Windows XP/2000/NT/9x/Me.
5. USB hard disks are currently not supported.
6. Does not support RAID/AHCI (class code 0104/0106) hard disks.
7. Capable of backing up and restoring only the first physical hard disk.

Hard disks detection sequence is as follows:

- a. PATA IDE primary channel
- b. PATA IDE secondary channel
- c. SATA IDE channel 1
- d. SATA IDE channel 2
- e. SATA IDE channel 3
- f. SATA IDE channel 4

### Precautions:

1. When using hard disks with more than 128G under Windows 2000, be sure to execute the EnableBigLba.exe program from the driver CD before data backup.
2. It is normal that data backup takes longer time than data restoration.
3. Xpress Recovery2 is compliant with the GPL regulations.
4. On a few motherboards based on Nvidia chipsets, BIOS update is required for Xpress Recovery2 to correctly identify RAID and SATA IDE mode. Please contact your motherboard manufacturer.
5. Xpress Recovery2 supports only PATA hard disks and not SATA hard disks on the following motherboards (As this is a BIOS-related issue, it can be solved by BIOS update)

GA-K8U	GA-K8NXP-9	GA-8N-SLI Royal
GA-K8U-9	GA-K8N Ultra-9	GA-8N-SLI Pro
GA-K8NXP-SLI	GA-K8NF-9 (PCB Ver. 1.0)	GA-8N-SLI
GA-K8N Ultra-SLI	GA-K8NE (PCB Ver. 1.0)	
GA-K8N Pro-SLI	GA-K8NMF-9	

## 4-1-2 BIOS Flash Method Introduction



### Method 1 : Q-Flash™ Utility

Q-Flash™ is a BIOS flash utility embedded in Flash ROM. With this utility, users only have to stay in the BIOS menu when they want to update BIOS. Q-Flash™ allows users to flash BIOS without any utility in DOS or Windows. Using Q-Flash™ indicating no more fooling around with any complicated instructions and operating system since it is in the BIOS menu.



Please note that because updating BIOS has potential risk, please do it with caution!! We are sorry that Gigabyte Technology Co., Ltd is not responsible for damages of system because of incorrect manipulation of updating BIOS to avoid any claims from end-users.

### Before You Begin:

Before you start updating BIOS with the Q-Flash™ utility, please follow the steps below first.

1. Download the latest BIOS for your motherboard from Gigabyte's website.
2. Extract the BIOS file downloaded and save the BIOS file (the one with model name.Fxx. For example, 8KNXPU.Fba) to a floppy disk.
3. Reboot your PC and press **Del** to enter BIOS menu.

The BIOS upgrading guides below are separated into two parts.

If your motherboard has dual-BIOS, please refer to **Part One**.

If your motherboard has single-BIOS, please refer to **Part Two**.

### Part One:

#### Updating BIOS with Q-Flash™ Utility on Dual BIOS Motherboards.

Some of Gigabyte motherboards are equipped with dual BIOS. In the BIOS menu of the motherboards supporting Q-Flash and Dual BIOS, the Q-Flash utility and Dual BIOS utility are combined in the same screen. This section only deals with how to use Q-Flash utility.

**In the following sections, we take GA-8KNXP Ultra as the example to guide you how to flash BIOS from an older version to the latest version. For example, from Fa3 to Fba.**

The BIOS file is Fa3  
before updating

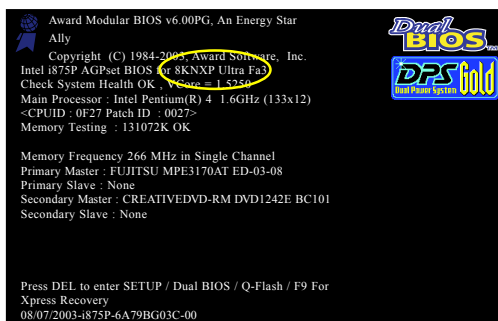

## Entering the Q-Flash™ utility:

Step1: To use Q-Flash utility, you must press **Del** in the boot screen to enter BIOS menu.

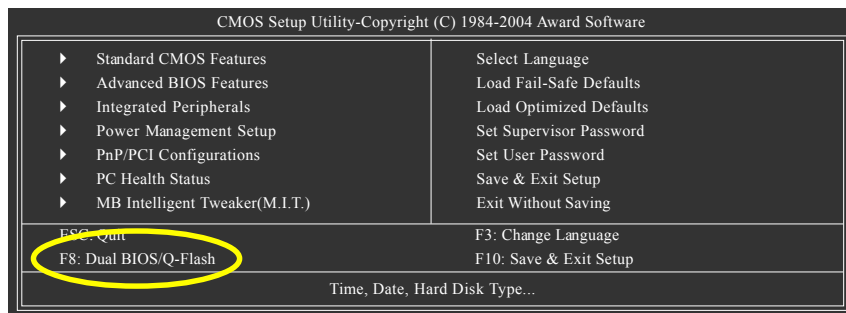

Step 2: Press **F8** button on your keyboard and then **Y** button to enter the Dual BIOS/Q-Flash utility.

## Exploring the Q-Flash™ / Dual BIOS utility screen

The Q-Flash / Dual BIOS utility screen consists of the following key components.

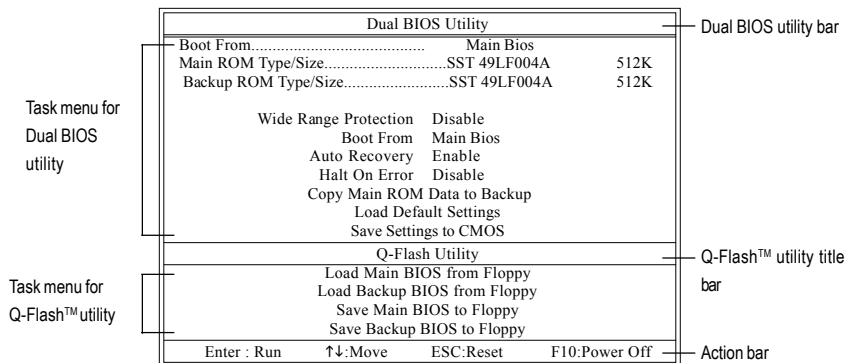

### Task menu for Dual BIOS utility:

Contains the names of eight tasks and two item showing information about the BIOS ROM type. Blocking a task and pressing Enter key on your keyboard to enable execution of the task.

### Task menu for Q-Flash utility:

Contains the names of four tasks. Blocking a task and pressing Enter key on your keyboard to enable execution of the task.

### Action bar:

Contains the names of four actions needed to operate the Q-Flash/Dual BIOS utility. Pressing the buttons mentioned on your keyboards to perform these actions.





- Press Y button on your keyboard after you are sure to update BIOS.  
Then it will begin to update BIOS. The progress of updating BIOS will be displayed.



Please do not take out the floppy disk when it begins flashing BIOS.

- Press any keys to return to the Q-Flash menu when the BIOS updating procedure is completed.

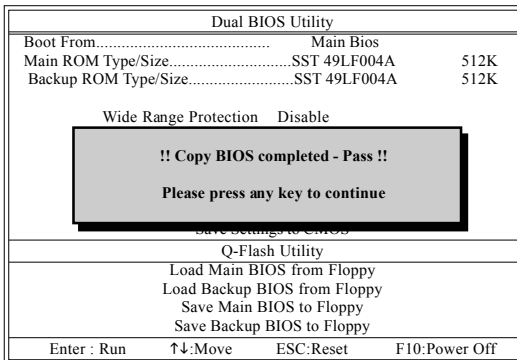

You can repeat Step 1 to 4 to flash the backup BIOS, too.

- Press Esc and then Y button to exit the Q-Flash utility. The computer will restart automatically after you exit Q-Flash.

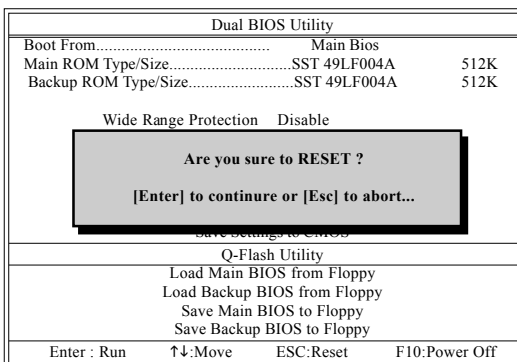

After system reboots, you may find the BIOS version on your boot screen becomes the one you flashed.

The BIOS file becomes Fab after updating.

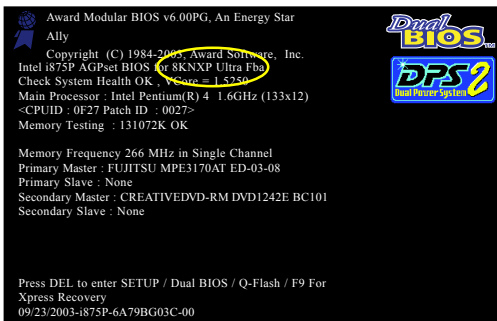

6. Press **Del** to enter BIOS menu after system reboots. When you are in BIOS menu, move to **Load Fail-Safe Defaults** item and press **Enter** to load BIOS Fail-Safe Defaults. Normally the system redetects all devices after BIOS has been upgraded. Therefore, we highly recommend reloading the BIOS defaults after BIOS has been upgraded.

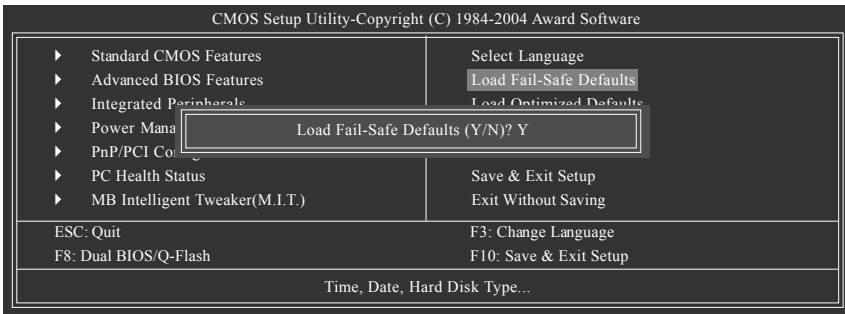

Press **Y** on your keyboard to load defaults.

7. Select **Save & Exit Setup** item to save the settings to CMOS and exit the BIOS menu. System will reboot after you exit the BIOS menu. The procedure is completed.

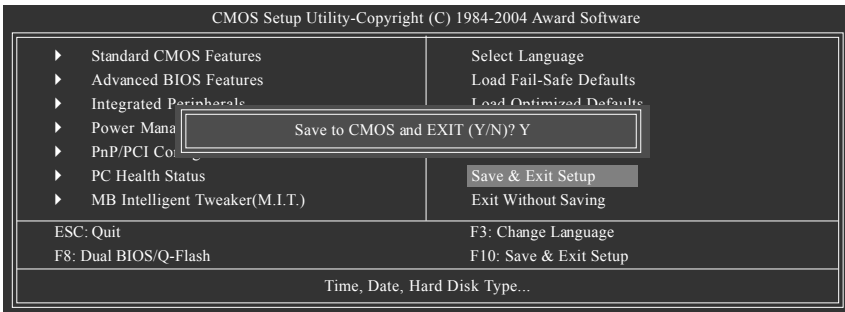

Press **Y** on your keyboard to save and exit.

## Part Two:

### Updating BIOS with Q-Flash™ Utility on Single-BIOS Motherboards.

This part guides users of single-BIOS motherboards how to update BIOS using the Q-Flash™ utility.

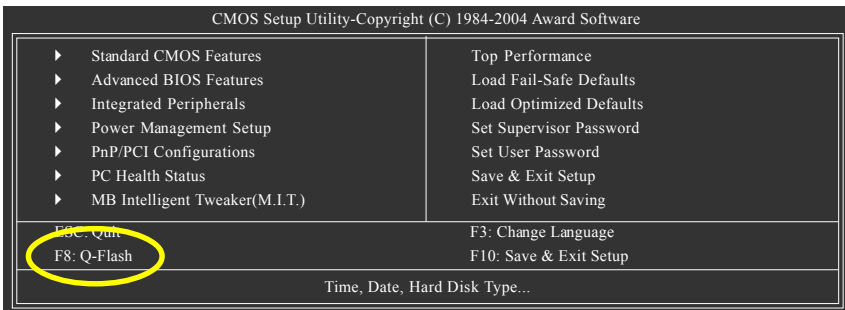



- Press Y button on your keyboard after you are sure to update BIOS.  
Then it will begin to update BIOS. The progress of updating BIOS will be shown at the same time.

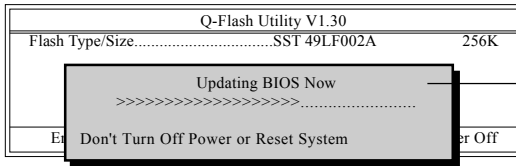

Do not turn off power or reset your system at this stage!!

- Press any keys to return to the Q-Flash menu when the BIOS updating procedure is completed.

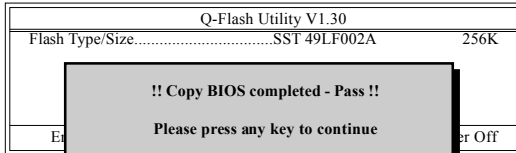

- Press Esc and then Y button to exit the Q-Flash utility. The computer will restart automatically after you exit Q-Flash.

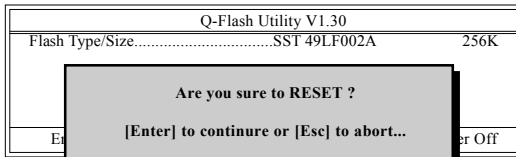

After system reboots, you may find the BIOS version on your boot screen becomes the one you flashed.

The BIOS file becomes F4 after updating

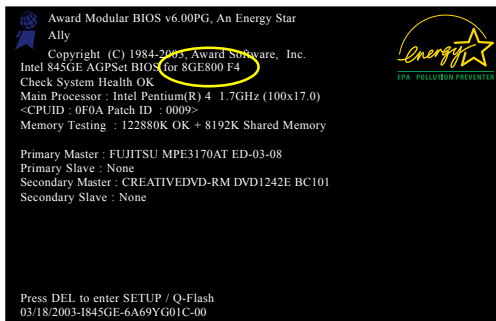

- Press Del to enter BIOS menu after system reboots and "Load BIOS Fail-Safe Defaults". See how to Load BIOS Fail-Safe Defaults, please kindly refer to Step 6 to 7 in **Part One**.

**Congratulation!! You have updated BIOS successfully!!**



## Method 2 : @BIOS™ Utility

If you do not have a DOS startup disk, we recommend that you use the new @BIOS utility. @BIOS allows users to update their BIOS under Windows. Just select the desired @BIOS server to download the latest version of BIOS.

Fig 1. Installing the @BIOS utility

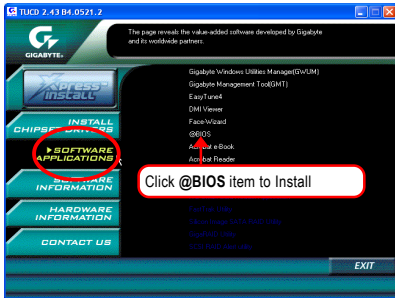

Fig 2. Installation complete and run @BIOS

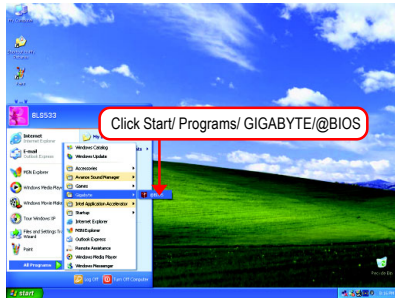

Fig 3. The @BIOS utility

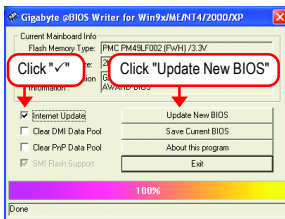
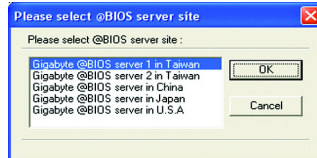

Fig 4. Select the desired @BIOS server



## 1. Methods and steps:

### I. Update BIOS through the Internet

- Select the **Internet Update** checkbox
- Click **Update New BIOS**
- Select an **@BIOS™** sever from which you want to download BIOS
- Select the exact model name of your motherboard
- System will automatically download and update the BIOS.

### II. Update BIOS NOT through the Internet:

- Do not select the **Internet Update** checkbox
- Click **Update New BIOS**
- Please select "All Files" in dialog box while opening the downloaded BIOS file.
- Please search for BIOS unzip file, downloading from the Internet or any other methods (such as: 661fxm775.F1).
- Complete update process following the on-screen instructions.

### III. Save BIOS

In the very beginning, there is **Save Current BIOS** icon shown in dialog box. It means to save the current BIOS version.

### IV. Check out supported motherboard and Flash ROM:

In the very beginning, there is "About this program" icon shown in dialog box. It can help you check out which kind of motherboard and which brand of Flash ROM are supported.

## 2. Note:

- I. In method I, if it shows two or more motherboard's model names to be selected, please make sure your motherboard's model name again. Selecting wrong model name will cause the system unbooted.
- II. In method II, be sure that motherboard's model name in BIOS unzip file are the same as your motherboard's. Otherwise, your system won't boot.
- III. In method I, if the BIOS file you need cannot be found in @BIOS™ server, please go onto Gigabyte's web site for downloading and updating it according to method II.
- IV. Please note that any interruption during updating will cause system unbooted.

## 4-1-3 Serial ATA BIOS Setting Utility Introduction

### RAID Levels

RAID (Redundant Array of Independent Disks) is a method of combining two hard disk drives into one logical unit. The advantage of an Array is to provide better performance or data fault tolerance. Fault tolerance is achieved through data redundant operation, where if one drives fails, a mirrored copy of the data can be found on another drive. This can prevent data loss if the operating system fails or hangs. The individual disk drives in an array are called members. The configuration information of each member is recorded in the reserved sector that identifies the drive as a member. All disk members in a formed disk array are recognized as a single physical drive to the operating system.

Hard disk drives can be combined together through a few different methods. The different methods are referred to as different RAID levels. Different RAID levels represent different performance levels, security levels and implementation costs. The RAID levels which the SiS® 964 chipset supports are RAID 0 and RAID 1.

#### RAID 0 (Striping)

RAID 0 reads and writes sectors of data interleaved between multiple drives. If any disk member fails, it affects the entire array. The disk array data capacity is equal to the number of drive members times the capacity of the smallest member. The striping block size can be set from 16KB to 256KB. RAID 0 does not support fault tolerance.

#### RAID 1 (Mirroring)

RAID 1 writes duplicate data onto a pair of drives and reads both sets of data in parallel. If one of the mirrored drives suffers a mechanical failure or does not respond, the remaining drive will continue to function. Due to redundancy, the drive capacity of the array is the capacity of the smallest drive. Under a RAID 1 setup, an extra drive called the spare drive can be attached. Such a drive will be activated to replace a failed drive that is part of a mirrored array. Due to the fault tolerance, if any RAID 1 drive fails, data access will not be affected as long as there are other working drives in the array.



Please follow the steps below to construct a complete RAID array:

- 1) Have ready your hard drives for RAID construction.  
Note: To achieve best performance, it is recommended that the hard drives used are of similar make and storage capacity.
- 2) Please attach the hard drive connectors to their appropriate location on the motherboard ie. IDE, SCSI, or SATA.
- 3) Enter the motherboard BIOS and locate RAID setup (Please refer to the section on Integrated Peripherals).
- 4) Enter RAID setup in the BIOS and select the RAID type (For instance, press Ctrl-S to enter SiS RAID BIOS).
- 5) Complete driver installation.
- 6) Complete RAID utility installation.

More information is provided on the steps below.

### Configuring the SiS RAID BIOS

The SiS RAID BIOS Setting Utility lets you choose the RAID array type and which hard drives you want to make part of the array.

Entering the RAID BIOS Setup

After rebooting your computer, wait until you see the RAID software prompting you to press Ctrl-S (Figure 1). The RAID prompt appears as part of the system POST and boot process prior to loading the OS. You have a few seconds to press Ctrl-S before the window disappears.

```

Silicon Integrated Systems Corp. RAID BIOS Setting Utility v1.05_964
(c) 2003-2005 Silicon Integrated Systems Corp. All Rights Reserved.

Press <Ctrl><S> to enter Setup Menu or <ESC> to skip waiting.

Primary Master:      ST3120026AS      111GB      UDMA6
Secondary Master:   ST3120026AS      111GB      UDMA6
  
```

Figure 1

Press Ctrl-S. The SiS RAID BIOS Setting Utility - Disk Status window appears (refer to Figure 2). To create RAID, press <R> to enter the RAID Setup utility.

```

SiS RAID BIOS Setting Utility

Disk Status

* Current Created Raid *

[R] : Enter Raid setup utility

[Q] : Exit current menu

Location  Model          Capacity  Mode      RAID Type
-----
Disk 1    ST3120026AS    111GB     UDMA 6    Single —
Disk 2    ST3120026AS    111GB     UDMA 6    Single
  
```

Figure 2

## Creating RAID Volume

### Step 1:

In the RAID Setup window, press <A> to create RAID volume (Figure 3).

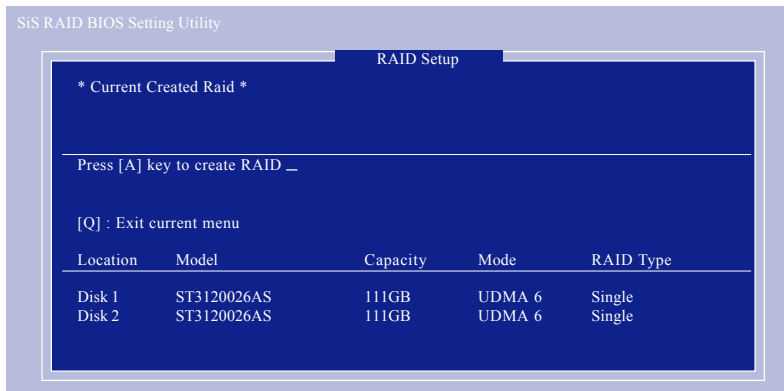

Figure 3

### Step 2:

Then, use number keys 1~3 to select a RAID type: (1)JBOD, (2)RAID 0, or (3)RAID 1 and then press <Enter> (Figure 4). In the following procedure, we'll create RAID 0 as an example.

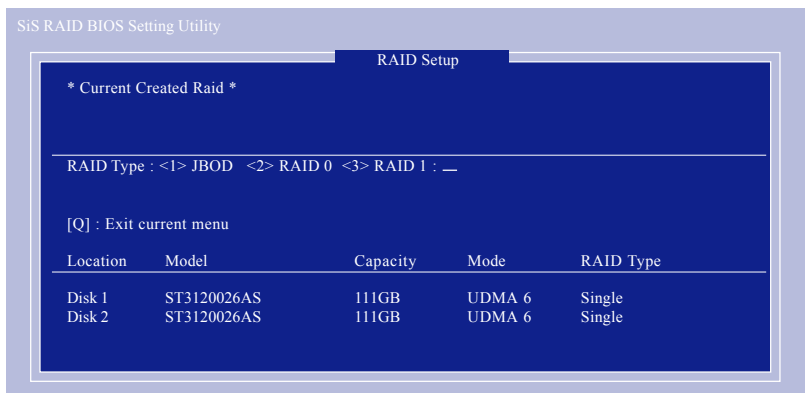

Figure 4

## Step 3:

If RAID 0 is selected, you'll have to decide whether you want the RAID array to be created automatically or manually (Figure 5). Use <1> or <2> key to select. (We do not suggest that you select <2> **Manual Create** unless you know well how to set every required item, like block size.)

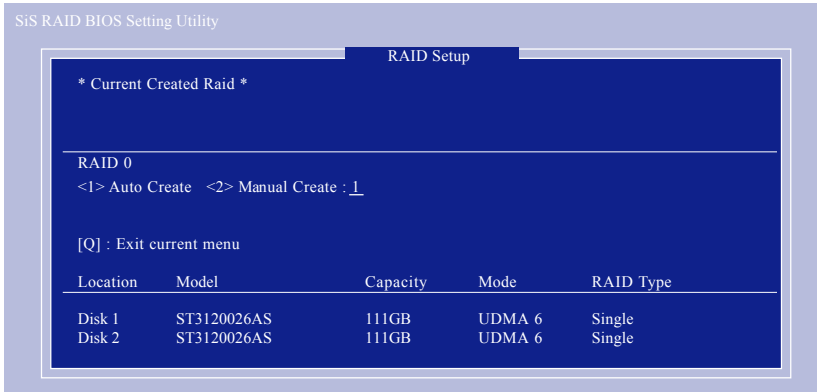

Figure 5

## Step 4:

If you wish to proceed to map and stripe all current data and future data to the RAID disks, press <Y>. Or press <N> to perform striping on future data only. Then press <Enter> (Figure 6).

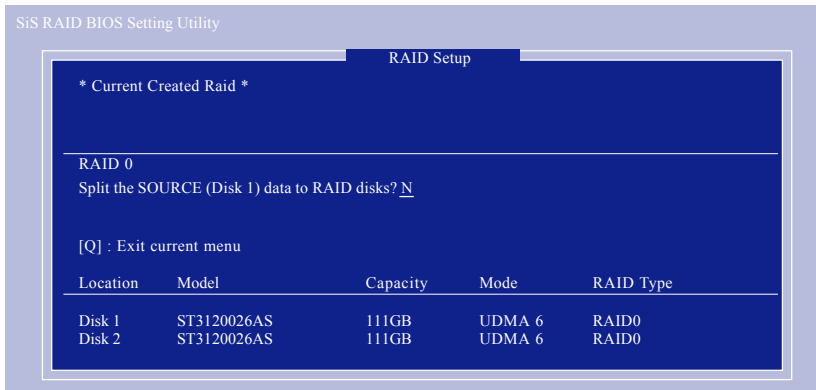

Figure 6

After the completion, you will see the RAID array under the \* **Current Created Raid** \* list in the RAID Setup window (Figure 7).

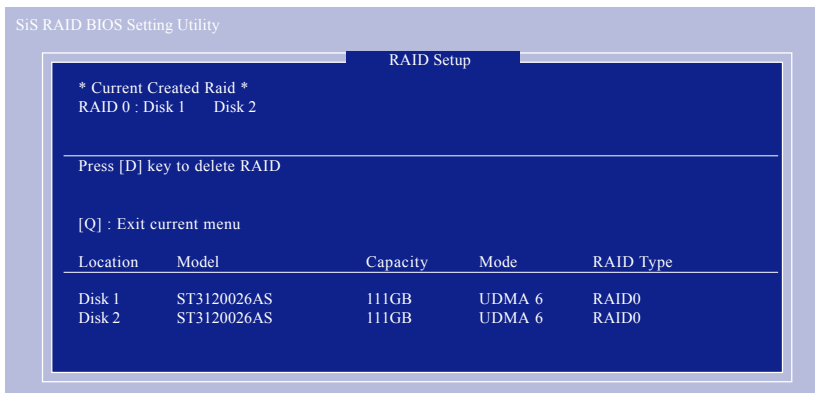

Figure 7

Step 5:

To exit the current menu, press <Q>. Until the "Do You Want to Save changes?" message appears (Figure 8), press <Y> and then <Enter> to confirm.

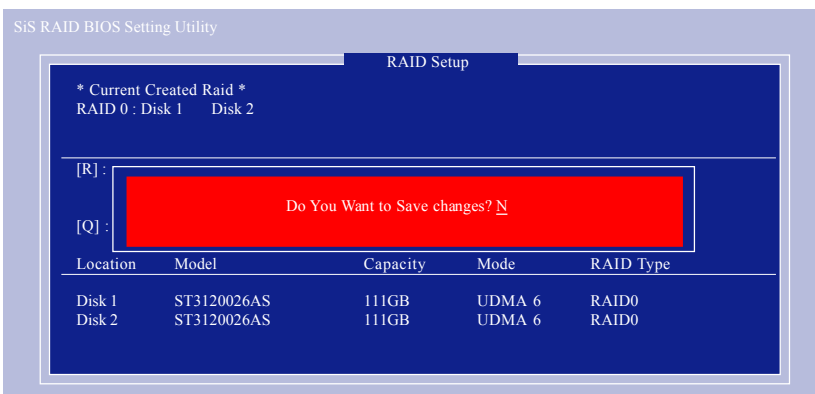

Figure 8

## Deleting RAID Volume

If you want to delete a RAID volume, simply press <D> in the following window (Figure 9) and then use arrow keys to select the RAID Volume and press <Enter> to confirm. Finally, when the "Are you sure to delete this RAID?" message appears, press <Y> to confirm your selections.

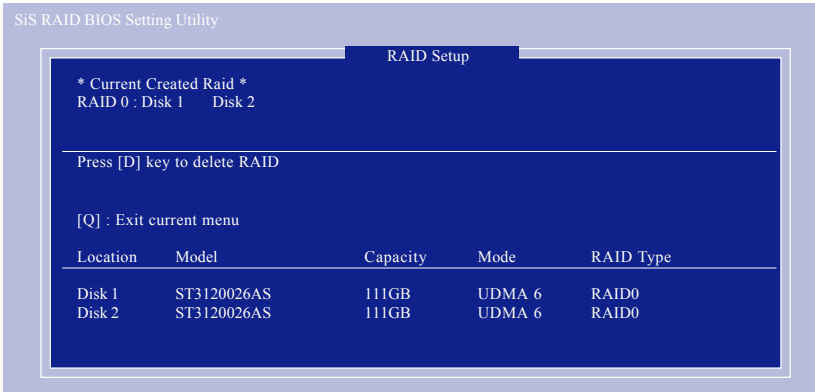

Figure 9

## Installing the RAID Drivers

To install Windows 2000/XP onto a Serial ATA hard disk successfully, you need to install required driver for the SATA controller on your motherboard during OS installation. Without the driver, the hard disk may not be recognized during the Windows setup process.

First of all, you have to copy the driver for the SATA controller on your motherboard from the motherboard driver CD to a floppy disk. See the instructions below about how to copy the driver.

### Step 1:

Find an available Operation System and insert the motherboard driver CD into the CD-ROM drive. The installation utility will appear automatically soon after you insert the driver CD. Quit the installation utility first. Insert a blank formatted floppy disk into the floppy disk drive.

### Step 2:

Go to **My Computer** and right-click the CD-ROM icon (This procedure assumes Drive D) and select **Open**. Then you will see folders and files contained in the driver CD. Double-click the BootDrv folder icon and select **MENU.exe** (refer to Figure10).

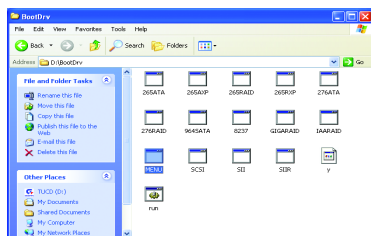

Figure 10

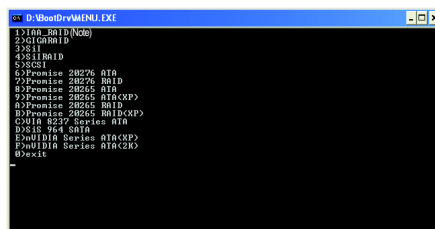

Figure 11

### Step 3:

A MS-DOS prompt screen will appear. Information on all chipsets should be listed on the screen (Refer to Figure 11), please select the proper chipset model.

Your system will then automatically zip and transfer this driver file to the floppy disk.

After you complete the steps, boot from the Windows CD to install the RAID drivers.

When install Windows 2000 or Windows XP from HDDs in serial ATA controller, press **F6** as Win2000 or XP boots up, then supply serial ATA controller driver by this floppy disk. Follow on-screen instructions to complete installation.

(Each time you add a new hard drive to a RAID array, the RAID driver will have to be installed under Windows once for that hard drive. After that, the driver will not have to be installed.)

Note: In the menu list, IAA\_RAID refers to Intel ICH5R chipset.



#### 4-1-4 2 / 4 / 6 Channel Audio Function Introduction

The following setup is for Windows 98SE/2000/ME/XP. Please follow the steps below to enable the function!

### 2 Channel Audio Setup

We recommend that you use speakers with amplifier to get the best sound effect if the stereo output is applied.

#### STEP 1:

Connect the stereo speakers or earphone to "Line Out."

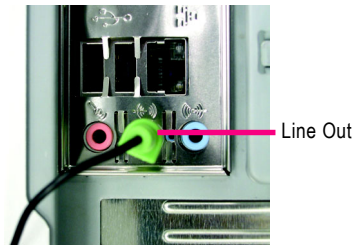

#### STEP 2:

After installing the audio driver, you'll find a Sound Effect icon  on the lower right hand taskbar. Click the icon to select the function.



#### STEP 3:

On the AC97 Audio Configuration menu, click the **Speaker Configuration** tab and select the **2-channel mode for stereo speaker output** check box.

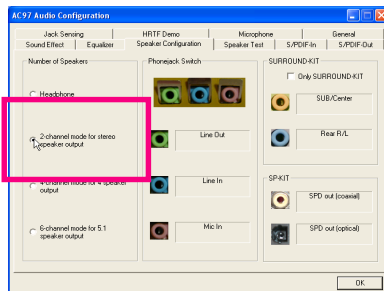
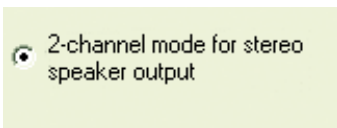

## 4 Channel Analog Audio Output Mode

### STEP 1:

Connect the front channels to "Line Out,"  
the rear channels to "Line In."

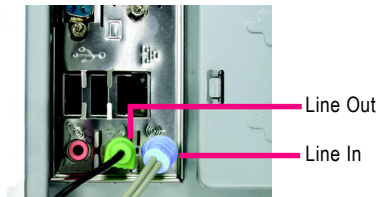

### STEP 2:

After installing the audio driver, you'll find a Sound Effect icon  on the lower right hand taskbar. Click the icon to select the function.



### STEP 3:

On the AC97 Audio Configuration menu, click the **Speaker Configuration** tab and select the **4-channel mode for 4 speaker output** check box. Clear the **Only SURROUND-KIT** check box and press **OK**.

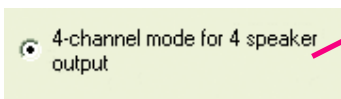

When the **Environment** setting is **None**, the sound would be performed as stereo mode (2-channel output). Please select other settings (ex: **Living Room**) for 4-channel output.

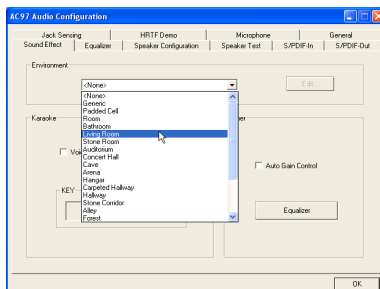



## Basic 6 Channel Analog Audio Output Mode

Use the back audio panel to connect the audio output without any additional module.

### STEP 1:

Connect the front channels to "Line Out", the rear channels to "Line In", and the Center/Subwoofer channels to "MIC In".

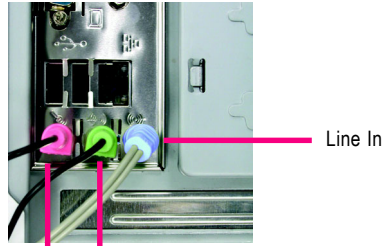

MIC In Line Out

### STEP 2:

After installing the audio driver, you'll find a Sound Effect icon  on the lower right hand taskbar. Click the icon to select the function.



### STEP 3:

On the AC97 Audio Configuration menu, click the **Speaker Configuration** tab and select the **6-channel mode for 5.1 speaker output** check box. Clear the **Only SURROUND-KIT** check box and press **OK**.

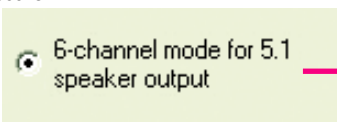

**Advanced 6 Channel Analog Audio Output Mode (using Audio Combo Kit,Optional Device):**

(Audio Combo Kit provides SPDIF output port : optical & coaxial and SURROUND-KIT : Rear R/L & CEN /Subwoofer)

SURROUND-KIT access analog output to rear channels and Center/Subwoofer channels. It is the best solution if you need 6 channel output, Line In and MIC at the same time. "SURROUND-KIT" is included in the GIGABYTE unique "Audio Combo Kit" as picture.

**STEP 1:**

Secure the metal bracket of the "Surround Kit" to the chassis back panel with a screw.

**STEP 2:**

Connect the "SURROUND-KIT" cable to the SUR\_CEN connector on the M/B.

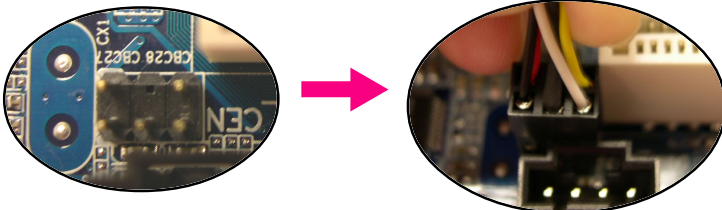

**STEP 3:**

Connect the front channels to back audio panel's "Line Out", the rear channels to SURROUND-KIT's REAR R/L, and the Center/Subwoofer channels to SURROUND-KIT's SUB CENTER.

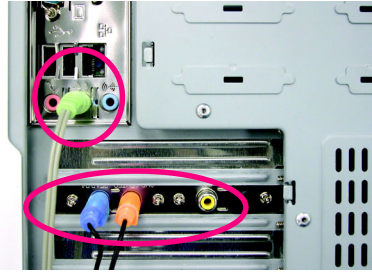

**STEP 4:**

After installing the audio driver, you'll find a Sound Effect icon on the lower right hand taskbar. Click the icon to select the function.

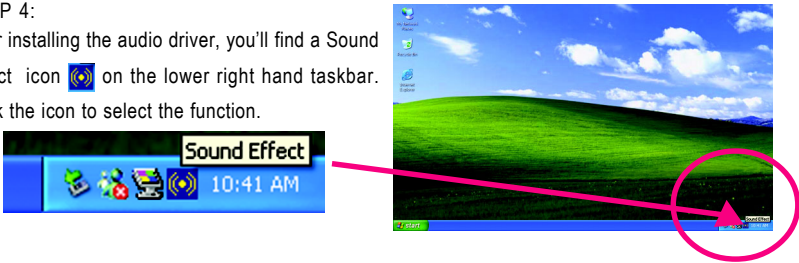

**STEP 5:**

On the AC97 Audio Configuration menu, click the **Speaker Configuration** tab and select the **6-channel mode for 5.1 speaker output** check box. Select the **Only SURROUND-KIT** check box and press **OK**.

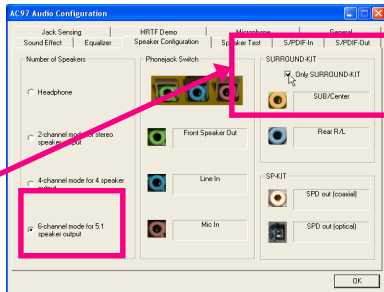
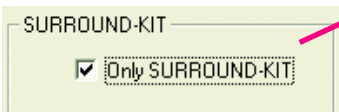

**Basic & Advanced 6 Channel Analog Audio Output Mode Notes:**

When the Environment setting is **None**, the sound would be performed as stereo mode (2-channel output). Please select the other settings for 6 channels output.

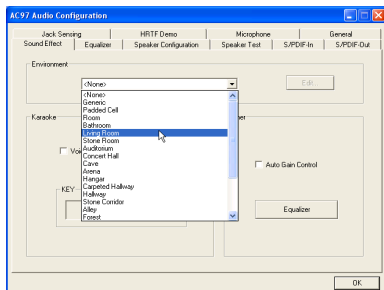

## SPDIF Output Device (Optional Device)

A "SPDIF output" device is an optional device. The SPDIF\_IO cable with rear bracket could link to the "SPDIF\_IO" connector (As picture.) For the further linkage to decoder, rear bracket provides coaxial cable and Fiber connecting port.

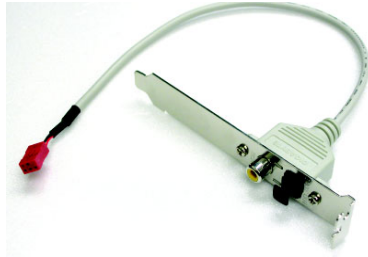

### STEP 1:

Secure the metal bracket of the SPDIF Output device to the chassis back panel with a screw.

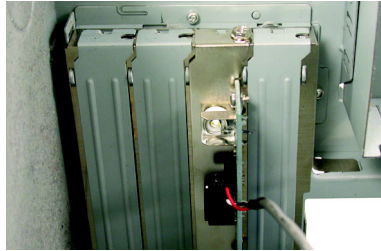

### STEP 2:

Connect the SPDIF device cable to the SPDIF\_IO connector on the motherboard.

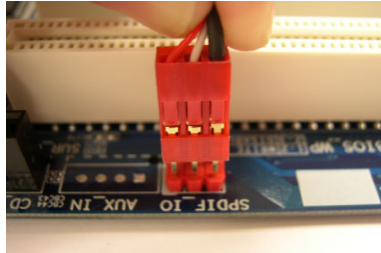

### STEP 3:

Connect SPDIF to the SPDIF decoder.

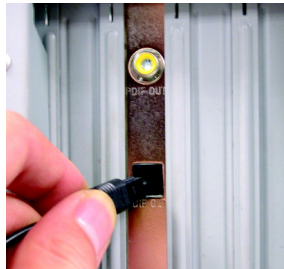

## Jack-Sensing Introduction

Jack-Sensing provides audio connectors error-detection function.



Install Microsoft DirectX8.1 first to enable Jack-Sensing support for Windows 98SE/2000 /ME.

Jack-Sensing includes 2 parts: AUTO and MANUAL. Following is an example for 2 channels (Windows XP):

### Introduction of audio connectors

You may connect CDRom, Walkman or other audio input devices to Line In jack, speakers, earphone, other output devices to Line Out jack, and microphone to MIC In jack.

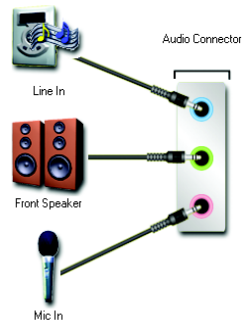

### Auto-detecting:

Please connect the devices to the right jacks as above. A window will appear as right picture if you setup the devices properly.

Please note that 3D audio function will only appear when 3D audio inputs.

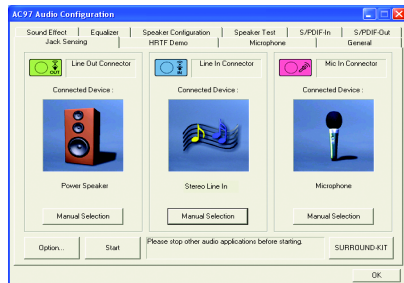

If you set wrong with the connectors, the warning message will come out as right picture.

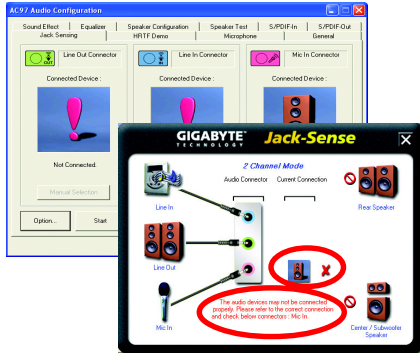

**Manual setting:**

If the device picture shows different from what you set, please press "Manual Selection" to set.

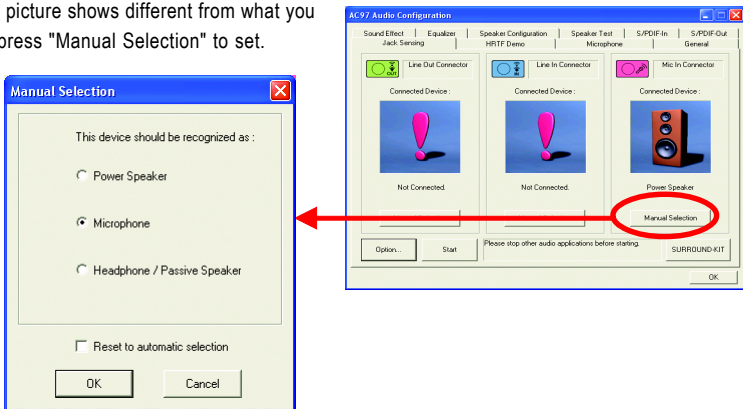

## 4-2 Troubleshooting

Below is a collection of general asked questions. To check general asked questions based on a specific motherboard model, please log on to [www.gigabyte.com.tw](http://www.gigabyte.com.tw)

Question 1: I cannot see some options that were included in previous BIOS after updating BIOS. Why?

Answer: Some advanced options are hidden in new BIOS version. Please press Ctrl and F1 keys after entering BIOS menu and you will be able to see these options.

Questions 2: Why is the light of my keyboard/optical mouse still on after computer shuts down?

Answer: In some boards, a small amount of electricity is kept on standby after computer shuts down and that's why the light is still on.

Question 3: How do I clear CMOS?

Answer: If your board has a Clear CMOS jumper, please refer to the Clear CMOS steps in the manual. If your board doesn't have such jumper, you can take off the on-board battery to leak voltage to clear CMOS. Please refer to the steps below:

Steps:

1. Turn off power.
2. Disconnect the power cord from MB.
3. Take out the battery gently and put it aside for about 10 minutes (Or you can use a metal object to connect the positive and negative pins in the battery holder to makethem short for one minute).
4. Re-insert the battery to the battery holder.
5. Connect power cord to MB again and turn on power.
6. Press Del to enter BIOS and load Fail-Safe Defaults(or load Optimized Defaults).
7. Save changes and reboot the system.

Question 4: Why do I still get a weak sound after turning up the speaker to the maximum volume?

Answer: Please make sure the speaker you are using is equipped with an internal amplifier. If not, please change another speaker with power/amplifier and try again later.

Question 5: Sometimes I hear different continuous beeps from computer after system boots up. What do these beeps usually stand for?

Answer: The beep codes below may help you identify the possible computer problems. However, they are only for reference purposes. The situations might differ from case to case.

→ AMI BIOS Beep Codes

\*Computer gives 1 short beep when system boots successfully.

\*Except for beep code 8, these codes are always fatal.

- 1 beep Refresh failure
- 2 beeps Parity error
- 3 beeps Base 64K memory failure
- 4 beeps Timer not operational
- 5 beeps Processor error
- 6 beeps 8042 - gate A20 failure
- 7 beeps Processor exception interrupt error
- 8 beeps Display memory read/write failure
- 9 beeps ROM checksum error
- 10 beeps CMOS shutdown register read/write error
- 11 beeps Cache memory bad

→ AWARD BIOS Beep Codes

- 1 short: System boots successfully
- 2 short: CMOS setting error
- 1 long 1 short: DRAM or M/B error
- 1 long 2 short: Monitor or display card error
- 1 long 3 short: Keyboard error
- 1 long 9 short: BIOS ROM error
- Continuous long beeps: DRAM error
- Continuous short beeps: Power error



















## Contact Us

---

- **Taiwan (Headquarters)**

GIGA-BYTE TECHNOLOGY CO., LTD.

Address: No.6, Bau Chiang Road, Hsin-Tien, Taipei 231, Taiwan

TEL: +886-2-8912-4888

FAX: +886-2-8912-4003

Tech. Support :

<http://tw.giga-byte.com/TechSupport/ServiceCenter.htm>

Non-Tech. Support(Sales/Marketing) :

<http://ggts.gigabyte.com.tw/nontech.asp>

WEB address (English) : <http://www.gigabyte.com.tw>

WEB address (Chinese) : <http://chinese.giga-byte.com>

---

- **U.S.A.**

G.B.T. INC.

TEL: +1-626-854-9338

FAX: +1-626-854-9339

Tech. Support :

<http://tw.giga-byte.com/TechSupport/ServiceCenter.htm>

Non-Tech. Support(Sales/Marketing) :

<http://ggts.gigabyte.com.tw/nontech.asp>

WEB address : <http://www.giga-byte.com>

---

- **Germany**

G.B.T. TECHNOLOGY TRADING GMBH

Tech. Support :

<http://tw.giga-byte.com/TechSupport/ServiceCenter.htm>

Non-Tech. Support(Sales/Marketing) :

<http://ggts.gigabyte.com.tw/nontech.asp>

WEB address : <http://www.gigabyte.de>

---

---

- **Japan**

NIPPON GIGA-BYTE CORPORATION

WEB address : <http://www.gigabyte.co.jp>

---

- **Singapore**

GIGA-BYTE SINGAPORE PTE. LTD.

Tech. Support :

<http://tw.giga-byte.com/TechSupport/ServiceCenter.htm>

Non-Tech. Support(Sales/Marketing) :

<http://ggts.gigabyte.com.tw/nontech.asp>

WEB address : <http://www.gigabyte.com.sg>

---

- **U.K.**

G.B.T. TECH. CO., LTD.

Tech. Support :

<http://tw.giga-byte.com/TechSupport/ServiceCenter.htm>

Non-Tech. Support(Sales/Marketing) :

<http://ggts.gigabyte.com.tw/nontech.asp>

WEB address : <http://uk.giga-byte.com>

---

- **The Netherlands**

GIGA-BYTE TECHNOLOGY B.V.

Tech. Support :

<http://tw.giga-byte.com/TechSupport/ServiceCenter.htm>

Non-Tech. Support(Sales/Marketing) :

<http://ggts.gigabyte.com.tw/nontech.asp>

WEB address : <http://www.giga-byte.nl>

---

---

- **China**

NINGBO G.B.T. TECH. TRADING CO., LTD.

Tech. Support :

<http://tw.giga-byte.com/TechSupport/ServiceCenter.htm>

Non-Tech. Support(Sales/Marketing) :

<http://ggts.gigabyte.com.tw/nontech.asp>

WEB address : <http://www.gigabyte.com.cn>

**Shanghai**

TEL: +86-021-63410999

FAX: +86-021-63410100

**Beijing**

TEL: +86-10-62102838

FAX: +86-10-62102848

**Wuhan**

TEL: +86-27-87851061

FAX: +86-27-87851330

**GuangZhou**

TEL: +86-20-87586074

FAX: +86-20-85517843

**Chengdu**

TEL: +86-28-85236930

FAX: +86-28-85256822

**Xian**

TEL: +86-29-85531943

FAX: +86-29-85539821

**Shenyang**

TEL: +86-24-23960918

FAX: +86-24-23960918-809

---

- **Australia**

GIGABYTE TECHNOLOGY PTY. LTD.

Tech. Support :

<http://tw.giga-byte.com/TechSupport/ServiceCenter.htm>

Non-Tech. Support(Sales/Marketing) :

<http://ggts.gigabyte.com.tw/nontech.asp>

WEB address : <http://www.giga-byte.com.au>

---

- **France**

GIGABYTE TECHNOLOGY FRANCE S.A.R.L.

Tech. Support :

<http://tw.giga-byte.com/TechSupport/ServiceCenter.htm>

Non-Tech. Support(Sales/Marketing) :

<http://ggts.gigabyte.com.tw/nontech.asp>

WEB address : <http://www.gigabyte.fr>

---



---

- **Russia**

Moscow Representative Office Of GIGA-BYTE Technology Co., Ltd.

Tech. Support :

<http://tw.giga-byte.com/TechSupport/ServiceCenter.htm>

Non-Tech. Support(Sales/Marketing) :

<http://ggts.gigabyte.com.tw/nontech.asp>

WEB address : <http://www.gigabyte.ru>

---

- **Poland**

Office of GIGA-BYTE TECHNOLOGY Co., Ltd. in POLAND

Tech. Support :

<http://tw.giga-byte.com/TechSupport/ServiceCenter.htm>

Non-Tech. Support(Sales/Marketing) :

<http://ggts.gigabyte.com.tw/nontech.asp>

WEB address : <http://www.gigabyte.pl>

---

- **Serbia & Montenegro**

Representative Office Of GIGA-BYTE Technology Co., Ltd. in SERBIA & MONTENEGRO

Tech. Support :

<http://tw.giga-byte.com/TechSupport/ServiceCenter.htm>

Non-Tech. Support(Sales/Marketing) :

<http://ggts.gigabyte.com.tw/nontech.asp>

WEB address: <http://www.gigabyte.co.yu>

---

- **Czech Republic**

Representative Office Of GIGA-BYTE Technology Co., Ltd. in CZECH REPUBLIC

Tech. Support :

<http://tw.giga-byte.com/TechSupport/ServiceCenter.htm>

Non-Tech. Support(Sales/Marketing) :

<http://ggts.gigabyte.com.tw/nontech.asp>

WEB address: <http://www.gigabyte.cz>

---

- **Romania**

Representative Office Of GIGA-BYTE Technology Co., Ltd. in Romania

Tech. Support :

<http://tw.giga-byte.com/TechSupport/ServiceCenter.htm>

Non-Tech. Support(Sales/Marketing) :

<http://ggts.gigabyte.com.tw/nontech.asp>

WEB address: <http://www.gigabyte.com.ro>

---